

**Deanship of Graduate Studies  
Al-Quds University**

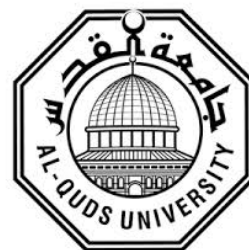

**Removal of Antibacterial Drugs Using Membrane  
Technology, Activated Charcoal, and Micelle-Clay  
Complex - Case Study: Amoxicillin Trihydrate, and  
Cefuroxime axetil**

**Mohammad Yousef Ahmad “Hamad Awwad”**

**M.Sc. Thesis**

**Jerusalem-Palestine**

**1435/2014**

Removal of Antibacterial Drugs Using Membrane  
Technology, Activated Charcoal, and Micelle-Clay  
Complex - Case Study: AmoxicillinTihydrate, and  
Cefuroxime axetil

Prepared By: Mohammad Yousef Ahmad HamadAwwad

Registration No.: 20920220

B.Sc.: Chemistry, Hebron University, Palestine

Supervisor: Professor Dr. Rafik Karaman

Co-supervisor: Dr. Fuad Al-Remawi

A thesis submitted in partial fulfillment of requirements for  
the degree of Master of Pharmaceutical Industry in Applied  
and Industrial Technology Program, Al-Quds University

Jerusalem-Palestine

1435/2014

**Al-Quds University**

**Deanship of Graduate Studies**

**Applied and Industrial Technology Program**

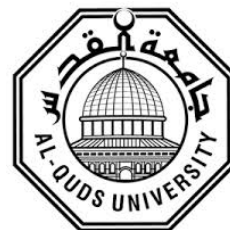

**Thesis Approval**

**Removal of Antibacterial Drugs Using Membrane Technology, Activated Charcoal, and Micelle-Clay Complex - Case Study: Amoxicillin Tihydrate, and Cefuroxime axetil**

**Student Name: Mohammad Yousef Ahmad HamadAwwad**

**Registration No.: 20920220**

**Supervisor: Prof Dr. Rafik Karaman**

**Co-supervisor: Dr. Fuad Al-Remawi**

Master thesis Submitted and Accepted: Date 13/8/2014.

The names and signatures of the examining committee members are as follows:

1- Head of Committee: Prof. Dr. Rafik Karaman

Signature: 

2- Committee Member: Dr. Fuad Al-Remawi

Signature: 

3- Internal Examiner: Dr. Jawad Sheqer

Signature: 

4- External Examiner: Dr. Rashid Al-Sa'ed

Signature: 

Palestine /Jerusalem

1435/2014

## **Dedication**

This thesis is dedicated to the teacher of teachers, **Prophet Mohammad** -peace be upon him.

To my wonderful parents who sacrificed a lot for me to be what I am now. I am very grateful for their unconditional love, support and prayers. Thank you for instilling in me the desire to strive for the best.

I dedicate this thesis to my dear country, Palestine. My dear land that I believe strongly will return to us some day.

## **Declaration**

I certify that the thesis submitted for the degree of master is the result of my own research, except where otherwise acknowledged, and that this thesis (or any part of the same) has not be submitted for a higher degree to any other university or institution.

Mohamad Yousef Ahmad “Hamad wwad”

Date: 13/8/2014

Sign:.....

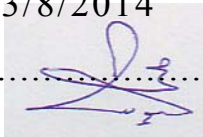
A handwritten signature in blue ink, appearing to be 'Mohamad Yousef Ahmad', written over a dotted line.

## **Acknowledgments**

First and foremost I would like to express my endless thanks to **God (Allah)** for conciliation and providing patience and success. As without his support I would not have managed to accomplish this thesis.

Then, I would like to thank my dear university, Al-Quds University and its professional staff who provided me with every source and advice that was needed for giving me the opportunity to obtain the M.Sc. degree in the Applied and Industrial Technology Program. For this great establishment and its staff, I am grateful.

In addition, I would like to thank my supervisor of this thesis Prof. Rafik Karaman for his continuous guidance, constructive criticism, and valuable suggestions. Also, I would like to extend my thanks to my co-supervisors Dr. Fuad Al-Rimawi for his help and support. I consider myself lucky to have such support and advice from them and to have them around me.

I would like to thank the staff of the center for chemical and biological research specially Mohannad Quire and Sameh Nuseibeh for their help.

In this special day I would like to thank all who supported me, encouraged me and had the tolerance to wait for this success to be made.

All respect, love and appreciation to all of you. Wishing all of you happiness and joy.

Jerusalem, Palestine

**Mohammad Awwad**

## Abstract

The efficiency of sequential advanced membrane technology wastewater treatment plant towards removal of amoxicillin trihydrate, and cefuroxime axetil from wastewater was investigated. The sequential system included activated sludge, ultrafiltration (hollow fiber membranes with 100 kDa cutoff, and spiral wound membranes with 20 kDa-cutoff), activated carbon column and reverse osmosis (RO). The overall performance of the integrated plant showed complete removal of amoxicillin trihydrate, and cefuroxime axetil from spiked wastewater samples. The adsorption isotherms for these compounds have been studied using both activated carbon adsorbent and newly developed adsorbent named micelle-clay complex (octadecyltrimethylammonium (ODTMA)-clay (montmorillonite) . The results revealed that both isotherms adsorption fit the Langmuir equation with  $Q_{\max}$  of  $100 \text{ mg g}^{-1}$  and  $90.91 \text{ mg g}^{-1}$ , and with K value  $0.229 \text{ L mg}^{-1}$  and  $0.158 \text{ L mg}^{-1}$  for amoxicillin trihydrate using activated carbon and micelle-clay complex, respectively, and with  $Q_{\max}$  of  $26.31 \text{ mg g}^{-1}$  and  $31.25 \text{ mg g}^{-1}$  and with K value  $0.271 \text{ L mg}^{-1}$  and  $0.122 \text{ L mg}^{-1}$  for cefuroxime axetil using activated charcoal and micelle-clay complex, respectively.

Removal of amoxicillin trihydrate and Cefuroxime axetil from polluted water in high concentration ( $100 \text{ mg L}^{-1}$ ) by column filter including a mixture of micelle-clay or activated charcoal composite with sand indicated efficient removal of both pharmaceuticals.

## Table of Contents:

Declaration .....	i
Acknowledgments .....	ii
Abstract.....	iii
Table of Contents: .....	iv
List of Tables.....	vii
List of Figures.....	viii
List of Abbreviations.....	ix
<b>Chapter One: Introduction</b> .....	2
1.1 Background.....	2
1.2 Thesis objectives .....	5
1.3 Thesis Outline.....	5
<b>Chapter Two:Literature Review:</b> .....	7
2.1 Introduction .....	7
2.3 Overview of wastewater treatment.....	8
2.4 Wastewater treatment plant process .....	8
2.4.1 Preliminary treatment.....	9
2.4.2 Primary treatment.....	9
2.4.3 Secondary treatment .....	9
2.4.4 Tertiary treatment.....	10
2.5 Membrane filtration .....	10
2.5.1Types of membranes.....	11
2.6 Occurrence of Pharmaceuticals and personal care products (PPCPs) in wastewater....	13
2.6.1 Analytical methods .....	14
2.6.2Antibiotic pharmaceuticals in wastewater .....	15
2.6.3 Method of treatment.....	16
<b>Chapter Three:Experimental:</b> .....	19
3.1 Part one.....	19
3.1.1 Instrumentation .....	19
3.1.1.1 High Performance Liquid Chromatography .....	19
3.1.1.2 UV-Spectrophotometer .....	19
3.1.1.3 pH meter.....	19



3.1.1.4 Centrifuge and Shaker .....	19
3.1.1.5 Description of Wastewater Treatment Plant (WWTP) .....	20
3.2 Part two.....	21
3.2.1 Chemicals and Reagents .....	21
3.2.1 Chemicals and Reagents .....	21
3.3 Part three.....	21
3.3.1.Methods(Amoxicillin Trihydrate , CefuroximAxetil) .....	21
3.3.1.1 Calibration curves using the solid phase cartridge .....	21
3.3.1.2 Efficiency of the wastewater treatment plant (WWTP) of Al-Quds University for removal of amoxicillin trihydrate and cefuroxim axetil .....	22
3.3.1.3Micelle-clay complex preparation .....	23
3.3.1.4 Adsorption studies onto micelle-clay complex and charcoal .....	23
3.3.1.4.1 Calibration curves .....	23
3.3.1.4.2. Batch adsorption isotherms.....	24
3.3.1.5. Column experiments:.....	24
<b>Chapter Four: Results and discussion:</b> .....	27
4.1 Amoxicillin Trihydrate .....	27
4.1.1 Introduction.....	27
4.1.2 Calibration curve for Amoxicillin Trihydrate using solid phase extraction cartridge (SPE).....	27
4.1.2.1 HPLC conditions for analysis of Amoxicillin Trihydrate .....	27
4.1.3 .... Efficiency of the wastewater treatment plant (WWTP) at Al-Quds University for the removal of Amoxicillin Trihydrate .....	28
4.1.4. Calibration curve for Amoxicillin Trihydrate using UV-visible spectrophotometer .....	31
4.1.5 Adsorption studies of Amoxicillin Trihydrate on a micelle-clay complex (ODTMA) and activated charcoal. ....	31
4.1.5.1 Adsorption of Amoxicillin Trihydrate on a micelle-clay complex (ODTMA) and activated charcoal.....	31
4.1.5.2Analysis Of Adsorption Isotherms .....	33
4.1.5.3 Column Experiments .....	36
4.2 Cefuroxime axetil .....	37
4.2.1 Introduction.....	37
4.2.2. Calibration curve for cefuroxime axetil using solid phase extraction cartridge (SPE).....	38

4.2.2.1 HPLC conditions for analysis of Cefuroxime axetil.....	38
4.2.3 .... Efficiency of the wastewater treatment plant (WWTP) at Al-Quds University for the removal of Cefuroxime axetil .....	38
4.2.4. Calibration curve for Cefuroxime axetil using uv-visible spectrophotometer.....	41
4.2.5 Adsorption studies of cefuroxim axetil on a micelle-clay complex (ODTMA) and activated charcoal.....	41
4.2.5.1 Adsorption of cefuroxim axetil on a micelle-clay complex (ODTMA) and activated charcoal.....	41
4.2.5.2 Analysis of adsorption isotherms.....	44
4.2.6 Column Experiments .....	46
<b>Chapter Five: Conclusions and Recommendations:</b> .....	48
5.1 Conclusions .....	48
5.2 Recommendations .....	48
References .....	50
الملخص: .....	59

## List of Tables

Table No	Table title	Page
1.1	Wastewater treatment plants (WWTP) in the West Bank	4
2.1	Comparison of pressure-driven systems	13
4.1	Removal of amoxicillin trihydrate through the hollow fiber (UF-HF), spiral wound (UF-SW), activated carbon adsorbent and reverse osmosis from the wastewater treatment plant at Al-Quds university.	29
4.2	Accumulative % removal of amoxicillin trihydrate	30
4.3	Percentage removal of amoxicillin trihydrate by micelle-clay complex (ODTMA) at pH 8.2	32
4.4	Percentage removal of amoxicillin trihydrate by activated charcoal	33
4.5	Concentrations in equilibrium obtained for adsorption test of amoxicillin trihydrate onto the adsorbent micelle-clay .( pH 8.2 and 25°C)	34
4.6	Concentrations in equilibrium obtained for adsorption test of amoxicillin trihydrate onto the adsorbent activated charcoal .( pH 8.2 and 25°C)	34
4.7	Langmuir adsorption parameters (k and $Q_{max}$ ) and the correlation coefficient ( $R^2$ ) values obtained from the adsorption of amoxicillin trihydrate on both adsorbents, a micelle-clay complex and activated charcoal.	35
4.8	Removal of amoxicillin trihydrate by filtration of its solution ( 100 mgL <sup>-1</sup> ) through a laboratory filter, which included either a micelle-clay complex , or activated carbon mixed with excess sand at 1:25 (w/w)	36
4.9	Removal of cefuroxime axetil through the hollow fiber (UF-HF), spiral wound (UF-SW), activated carbon adsorbent and reverse osmosis from the wastewater treatment plant at Al-Quds university	39
4.10	Accumulative % removal of cefuroxime axetil	40
4.11	Percentage removal of cefuroxime axetil by micelle-clay complex (ODTMA) at pH 8.2	42
4.12	Percentage removal of cefuroxime axetil by activated charcoal	43
4.13	Concentrations in equilibrium obtained for adsorption test of cefuroxim axetil onto the adsorbent micelle-clay .( pH 8.2 and 25°C)	44
4.14	Concentrations in equilibrium obtained for adsorption test of cefuroxim axetil onto the adsorbent activated charcoal .( pH 8.2 and 25°C)	44
4.15	Langmuir adsorption parameters (k and $Q_{max}$ ) of cefuroxime axetil onto micelle-clay complex and activated charcoal adsorbents	45
4.16	Removal of cefuroxime axetil by filtration of its solution ( 50 ppm) through a laboratory filter, which included either a micelle-clay complex , or activated carbon mixed with excess sand at 1:25 (w/w).	46

## List of Figures

Figure No	Figure title	Page
2.1	Hollow fiber (a) and spiral wound (b) modules	12
3.1	Flow diagram showing the process of wastewater treatment plant which consists of HF-UF filters (hollow fiber) and SW-UF (spiral wound), activated carbon and RO filters. Sampling locations are indicated by numbers	22
3.2	OctaDecylTrimethyl Ammonium (ODTMA)	23
4.1	.Structure of amoxicillin trihydrate	27
4.2	Calibration curve by using SPE for amoxicillin trihydrate	28
4.3	Chromatograms showing the initial concentration of amoxicillin trihydrate (a) and after running the HF-UF point (b)	30
4.4	Concentration of amoxicillin trihydrate before and after running the SW-UF point, (a,b), Respectively	30
4.5	Chromatogram showing the concentration of amoxicillin trihydrate after running activated charcoal adsorbent point	30
4.6	calibration curve of amoxicillin trihydrate	31
4.7	Adsorption of amoxicillin trihydrate by micelle- clay complex (ODTMA) at pH 8.2	32
4.8	Adsorption of amoxicillin trihydrate by charcoal at pH 8.2	33
4.9	Langmuir isotherms for the removal of amoxicillin trihydrate by micelle-clay complex (◆) and by activated charcoal (■) .(pH 8.2, 25°C)	35
4.10	Conc. Of amoxicillin trihydrate Vs. Volume Of Samples Were Taken From micelles Clay And Charcoals Column	37
4.11	Structure of cefuroxime axetil	37
4.12	Calibration curve by using SPE for cefuroxime axetil	38
4.13	Chromatograms showing the initial concentration of cefuroxime axetil (a), and after running the HF-UF point (b)	40
4.14	Concentration of cefuroxime axetil before and after running the SW-UF point, (a&b), Respectively	40
4.15	Chromatogram showing the concentration of cefuroxime axetil after running activated charcoal adsorbent point	40
4.16	calibration curve of cefuroxim axetil	41
4.17	Adsorption of cefuroxime axetil by micelle-clay complex (ODTMA) at pH 8.2	42
4.18	Adsorption of cefuroxime axetil by charcoal at pH 8.2	43
4.19	Langmuir isotherms for the removal of cefuroxim axetil by activated charcoal (■) and by clay complex (◆) . (pH 8.2, 25°C)	45
4.20	Conc. Of cefuroxime Axetil Vs. Volume Of Samples Were Taken From mickle- Clay And Charcoals Column	46

## List of Abbreviations

BOD	Biological Oxygen Demand
CM C	Critical Micelle Concentration
COD	Chemical Oxygen Demand
Da; (g mol <sup>-1</sup> )	Dalton
HF	Hollow Fiber
HPLC	High Pressure Liquid Chromatography
Kd	Kilodalton
Ko/w	Octanol-water Partition coefficient
kP	Kilopascal
LPMS	Low-Pressure driven membrane
MF	Microfiltration
MWCO	Molecular weight Cutoff
NF	Nanofiltration
ODTMA	Octadecyltrimethylammonium
OTC	Over the counter
OWCs	Organic Wastewater Contaminants
PCPs	Personal Care Products
PNA	Palestinian National Authority
PPCPs	Pharmaceuticals and Personal Care Products
Ppm	Part per million
PWA	Palestinian Water Authority
RO	Reverse Osmosis
SPE	Solid Phase Extraction
SPME	Solid Phase Microextraction

STP	Sewage Treatment Plants
SW	Spiral Wound
TDS	Total Dissolved Solids
TOC	Total organic carbon
TOD	Total Oxygen Demand
TSS	Total Suspended Solids
UF	Ultrafiltration
UV	Ultra Violet
WHO	World Health Organization
WWTPs	Waste Water Treatment Plants

## **Chapter one**

# **Introduction**

# Chapter One

---

## Introduction

### 1.1 Background

In the Middle East, in general, and Palestine, in particular, water resources are very limited and currently a serious shortage problem exists [1-3].

This situation will be aggravated in the future since the water balance gap between the available water supplies and the water demand will increase as a result of population growth, rapid urbanization and industrialization associated with living standards improvement. This gap will cause serious shortage of fresh water to be used for human purposes, agricultural, and other non-human purposes, Hence, water contamination and the production of large volume of wastewater are the expected results [3-6].

The water consumption in Palestine which is considered as a semi arid country is divided among three principle sectors: (1) Agricultural sector consumes around 70%, and represent the largest consumer of water in Palestine, (2) Domestic sector which consumes about 27% of water consumption, (3) and finally industrial sector which uses only 3% of the total water used [4].

The ground water is the main source of fresh water in Palestine. The aquifer system forms three main ground water drainage basins, the first is in western part of the West Bank, the second in northeastern part of the West Bank, and the third is in eastern part of the West Bank. The sources of fresh water in Palestine suffer from Israeli confiscation and control [8].

Compared to groundwater, surface water is the insignificantly important in the West Bank. The only source of surface water in the area is the Jordan River; Palestinian access to fresh surface water from the Jordan River is almost zero because of Israel's control of the flow of the river [1].

This situation requires us to preserve all water supplies that currently exist, control water usage and use it efficiently, and minimize water pollution and water contamination by



reducing wastewater flows and also finding solutions for disposal, treatment and recycling of wastewater.

Due to water shortage, the treatment of wastewater has become of increasing interest, in order to protect water sources and supplement the available amount of water for irrigation. The level of treatment is still a controversial issue. Quite a few countries are moving rapidly towards advanced treatment by which wastewater approaches fresh water quality [9,10].

Wastewater is one of the major sources of pollution that has serious hostile impact both on the environment and local residents. The wastewater sector status in Palestine is characterized by poor sanitation, different quality, insufficient treatment, and unsafe disposal of untreated or partially treated wastewater into the environment. Sewage collection networks in the West Bank are limited to major cities and to certain portions of these municipalities. Most of them are poorly designed and old [4,10]. Therefore, the situation of the sewerage system is extremely critical [11].

The efficient sewage treatment systems are urgently needed in Palestine, because an appropriate and a sustainable sewage treatment technology will help to preserve biodiversity and maintain healthy ecosystems [4].

Various methods for wastewater treatment have been used in Mediterranean countries, many are conventional such as activated sludge and biofilters and others slightly less conventional, such as oxidation ditches, aerated lagoons and natural treatment system such as waste stabilization ponds [11].

In Palestine two types of treatment plant systems are used conventional and less conventional: stabilization ponds for small communities, trickling filter, oxidation ditches, and activated sludge for large scale community. Table 1-1 lists the current status of existing and planned wastewater treatment in the west bank [4].

**Table 1.1: Wastewater treatment plants (WWTP) in the West Bank [4].**

Name Of T.P	Status of T.P	No Of Population Served Buy T.P*1000 (year)	Capacity Of T.P (mcm/year)	Funding Agency	Estimated Cost For Construction (Million \$US)	Technology
Nablus East	Planing phase	240(2021)	9.2	Germany KFW	25	Extended Aeration
Nablus West	Approved	225(2021)	9.0	Germany KFW	25	Extended Aeration
Salfit	Detailed study	24(2025)	2.3	Germany KFW	13	Extended Aeration
Jenin*	Rehabilitation is needed	13.5(1997)	0.5	Israel		Waste stabilization ponds
Al-Bireh	Constructed	40(2000)	1.1	Germany KFW	7	Oxidation ditch
Tulkarem**	No study yet	223(2030)	7.5	Germany KFW	50	Extended Aeration process
Abu-Dees	Feasibility study	26(2020)	1	Norway		Oxidation ditch
Tafuh	Feasibility study	16	0.5	UNDP		Anaerobic rock filter
Halhul	Preliminary design	42(2020)	1.0	Not funded	5.5	Aerated pond system
Birzeit Area	Preliminary study	28(1994)	1.2	Not funded	4.5	Imhoff tank and trickling filter
Hebron	Planning stage	695(2020)	25.0	USA	45	Activated sludge
Jericho	Preliminary study	26(2000)	1.2	Not funded		
Biddya	Preliminary study	24(2000)	1.1	Not funded	10.0	
Ramallah** *	Feasibility study	40(North)	1.5	Not funded	7.0	Extended Aeration
		40(South)	1.5		7.0	
Al-Ram	Preliminary study	86.5(2000)	3.3	Germany KFW	11.0	Aerobic sludge stabilization + activated sludge
Total		1789	66.3		210	

**Note:** \*Old and non-functioning sewage treatment plant exists. \*\*Currently rehabilitation of the sewage treatment plant takes place. \*\*\* Currently rehabilitation of the old sewage treatment plant takes place as a partial solution. (KFW: KreditanstaltFuerWiederaufbau, T.P: Treatment Plant).

## **1.2 Thesis objectives**

The goal of this study is to investigate the performance of advanced treatment technologies which include integration between activated sludge process with ultra-filtration membranes (hollow fiber and spiral wound membranes), activated carbon adsorbent, micelle-clay filters, and reverse osmosis in terms of amoxicillin trihydrate and cefuroxime axetil removal from synthetic wastewater sample.

In addition, the removal of amoxicillin trihydrate and cefuroxime axetil by using filters that include micelle-clay complex and activated carbon and its adsorption isotherms in suspension was also studied.

## **1.3 Thesis Outline**

This thesis contains five chapters: Chapter 1 contains the introduction, Chapter 2 consists of literature review on pharmaceuticals present in wastewater, general information on wastewater and the technology used for its treatment, Chapter 3 reviews the materials and the methods used, as well as sampling and analysis, Chapter 4 summarizes the results and presents discussion, and Chapter 5 presents the conclusions, recommendations and references.

## **Chapter Two**

# **Literature Review**

## **Chapter Two:**

---

### **Literature Review:**

#### **2.1 Introduction**

Wastewater contains a mixture of both organic and inorganic constituents. Its composition varies from time to time and place to place, basically depending on economic aspects, social behavior, type and number of industries located around the collection area, climatic conditions, water consumption, and the type and condition of the sewer system [13].

#### **2.2 Wastewater: Definition and Characteristics**

The more specific definition of wastewater is a combination of water carried wastes removed from residence, institution, commercial, industrial establishments, and ground water [14].

Wastewater is about 99% water by weight referred as influent, and the remaining one percent includes suspended and dissolved organic substances, as well as microorganisms [15].

but this ratio may varies according to the activity that wastewater resulted from, but the constituents ratio is not less than 95% water, as water is often added during the flushing to carry the waste down a drain [14].

The wastewater sources can be divided into two types, domestic wastewater, or “sewage” and this type resulted from homes, commercial places, and farms [16].

Domestic wastewater can also be divided into two elements, black water which originates from toilets and kitchens and is highly contaminated and, grey water which originates from baths, showers, wash basins and washing machine and is generally less contaminated. Grey water makes up 40% - 60% of the total domestic wastewater volume [17].

Industrial/commercial wastewater is flow generated and discharged from manufacturing and commercial activities, a combination of domestic and industrial wastewater constituents is known as municipal wastewater [18].

Wastewater is characterized in terms of its physical, chemical, and biological composition [20] Physical parameters include total solid contents, particle size distribution, turbidity, temperature, conductivity, transmittance, density, color, and odor. Total solid contents are subdivided into total suspended solids (TSS) and total dissolved solids (TDS). Chemical parameters associated with the organic content of wastewater include biochemical oxygen demand (BOD), chemical oxygen demand (COD), total organic carbon (TOC), and total oxygen demand (TOD).

Inorganic chemical parameters include salinity, hardness, pH, acidity and alkalinity, as well as concentrations of ionized metals such as iron and manganese, and anionic entities such as chlorides, sulfates, sulfides, nitrates, and phosphates.

Bacteriological parameters include coliforms, fecal coliforms, specific pathogens, and viruses [13,19].

### **2.3 Overview of wastewater treatment**

Wastewater treatment is the process of removing varying amounts of contaminants from wastewater, depending on the level and type of treatment they provide. Its objective is to optimize the benefits of wastewater as a resource of both water and nutrients, and to ensure protection of public health and the environment from the discharge of untreated or inadequately treated wastewater effluents [20].

Also, in wastewater reclamation and reuse, water quality requirements may call for reduction in suspended solids, total dissolved solids, pathogenic microorganism (i.e. bacteria, protozoan, and viruses), as well as selected constituents such as nitrates, chlorides, and natural and synthetic organic compounds [13].

### **2.4 Wastewater treatment plant process**

Treatment facilities incorporate numerous processes, which in combination achieve the desired water quality objectives. These processes involve the separation, removal and disposal of pollutants present in the wastewater.

The treatment of wastewater is accomplished by four basic methods or techniques; physical, mechanical, biological and chemical. The physical method of treatment is unit operations used in wastewater treatment include; flow-metering, screening, mixing, sedimentation, accelerating gravity settling, floatation, filtration gas transfer and volatilization. Mechanical treatment methods involve the use of machines. Chemical treatment methods include many processes such as chemical precipitation, adsorption, disinfection, and dechlorination. The biological method which plays a vital role in the removal of pollutants which cannot be effectively achieved by other means like bacteria and microorganisms [18, 21].

Water treatment usually consists of four stages: preliminary, primary, secondary, and tertiary. But the primary and secondary stages are considered the major steps, and the tertiary stage is required to achieve complete removal for pollutants which have not been removed by secondary treatment [15].

#### **2.4.1 Preliminary treatment**

The influent that flows to treatment plant contains pieces of wood, rags, plastic and other debris in addition to sand, eggshells and other coarse inorganic materials, as well as organic matter from household, industrial, commercial and institutional water use, all these components are removed through combination of screening and settling [13,18, 22,23].

#### **2.4.2 Primary treatment**

In primary treatment, the objectives are to physically remove, large debris, grit and sands from wastewater by screening, settling, or floating [15].

During primary treatment wastewater flows into and through large settling tanks or clarifiers where the flow velocity is reduced. Here initial separation occurs, with 40% to 50% of the heavier settleable solids forming primary sludge on the bottom of the settling tanks, and lighter materials float to the tanks surface [18].

#### **2.4.3 Secondary treatment**

The secondary treatment is designed for removal of biodegradable dissolved and colloidal organics and suspended solids that have escaped the primary treatment by utilizing biological treatment process. In secondary treatment unit, three types of technologies can

be applied to break down organic material with agitation and aeration. There are: activated sludge process, trickling filters, and lagoon system [13, 22].

Activated sludge process removes the dissolved organic material and converts colloidal matter to a biological sludge which rapidly settles. The activated sludge process uses a variety of mechanisms to utilize dissolved oxygen to promote the growth of biological floc that substantially breaks down and removes organic material, then allows these solids floc to settle out [18, 23-24].

#### **2.4.4 Tertiary treatment**

Any additional processing after secondary treatment is called tertiary treatment which is physical-chemical processes applied to remove more suspended solids, organic matter, nitrogen, phosphorous, heavy metals and bacteria. These processes include, ozonation, photo-catalytic degradation of recalcitrant compounds (UV/TiO<sub>2</sub>), and adsorption [19, 24-25].

Tertiary treatment may also involve physical-chemical separation techniques such as carbon adsorption, flocculation/precipitation, membranes for advanced filtration, ion exchange, dechlorination and reverse osmosis [26].

#### **2.5 Membrane filtration**

Membrane filtration are frequently used for tertiary treatment of wastewater before discharge to surface water, recover materials in industry before they enter waste streams, and to treat waters for potable use [27].

Application of membrane technology to wastewater treatment has expanded due to increasingly stringent legislation and continuing advancement of membrane technology [28].

Membrane filtration technology is a separation process, in which a semi-permeable membrane acts as a filter that allows water flow through, while removing suspended solids and other substances [29].



In membrane separation process, the feed water is separated into stream that can pass through the membrane known as permeate, and a fraction of feed that cannot pass through the membrane known as retentate or concentrate [30].

The removal of suspended or colloidal particles based on the size of membrane pores relative to that of the particulate matter, in the applications that require the removal of dissolved contaminants, the molecular weight cutoffs (MWCO) is considered the main criteria for effective separation, because it specifies the maximum molecular weight of solute to be rejected, the removal process will be in range of 100 to 500 Daltons [29].

Other parameters such as the kind of driving force (pressure, chemical structure and composition of membrane, geometry of construction , and type of feed flow) play a vital role in the membrane filtration process [27].

### **2.5.1 Types of membranes**

There are four main types of modules: plat, frame, tubular spiral wound, and hollow fiber [31].

Hollow fiber and spiral wound modules constructions involves sealing the membrane material into an assembly, these types of modules are designed for long-term use ( number of years), these modules are used in drinking water treatment and also wastewater treatment [13, 32].

Hollow fiber and spiral wound are made from organic material (synthetic polymers i.e. polyamide, polysulphone). Hollow fibers are a narrow tube made of non-cellulosic polymer, in this type a bundles of individual fibers are sealed into a hydraulically housing as shown in Figure 2-1, the fibers usually have a small diameter. In hollow fiber the feed flows into the module, the permeate flow into or out of the hollow fiber and is collected, while retentate exits the module for further treatment [33-34].

Spiral wound is one of the most compact and inexpensive membrane, in this type two flat sheet membranes are placed together with their active sides facing away from each other. Each flat sheet membrane has one active side through which the smaller molecules permeate through, a feed spacer which is a mesh like material is placed between the two flat sheet membranes, the two flat sheet membranes with feed spacer separating them are rolled around perforated tube which called collection tube Figure 2-1.

Membrane filtration can basically be divided into four main technologies based on the driving force used for filtration: Microfiltration (MF), ultrafiltration (UF), nanofiltration (NF), and reverse osmosis (RO). Hollow fiber and spiral wound are used for microfiltration (MF), ultrafiltration and also reverse osmosis (RO) [35].

The driving force can be external pressure, electrical potential gradient, concentration gradient, or other driving forces, the most commonly used membrane system in water and wastewater treatment are pressure-driven membrane. Microfiltration (MF), ultrafiltration (UF), nanofiltration (NF), and reverse osmosis (RO) use the pressure-driven force and are classified according to their pore size, Table 2-1 shows the separation characteristic for various pressures-driven membrane process [27, 36].

There are different studies about reverse osmosis, nano and ultrafiltration applied to the antibiotics removal. In most studies, the percentage removal obtained for different membrane types was higher than 90% for all the antibiotic classes were studied obtained the lowest values for the removal of tetracyclines (50-80%) and sulphonamides (11-20%) [76].

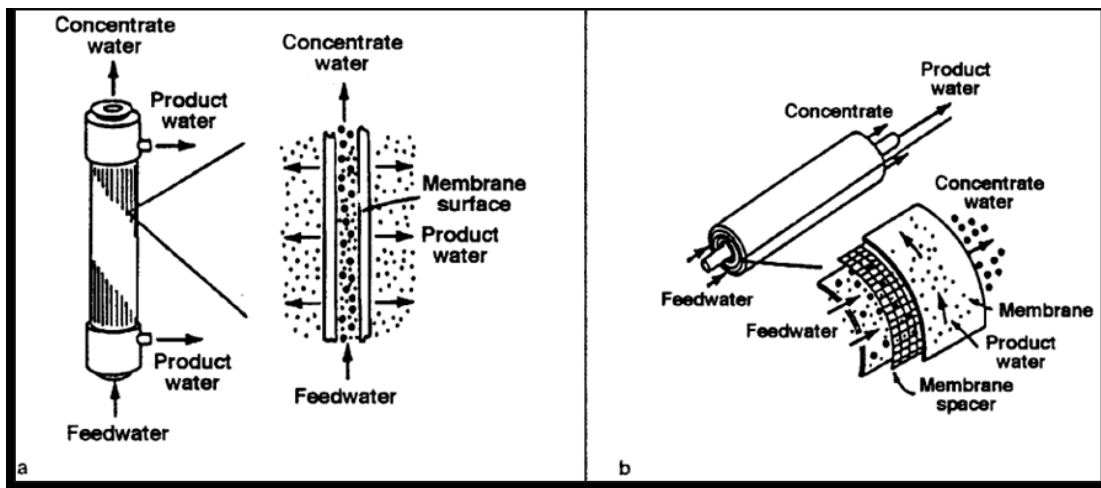

Figure 2.1: Hollow fiber (a) and spiral wound (b) modules.

**Table 2.1 : Comparison of pressure-driven systems**

Parameters	Membrane system			
	Low- pressure membrane		High- pressure membrane	
	Microfiltration (MF)	Ultrafiltration (UF)	Nanofiltration (NF)	Reverse Osmosis (RO)
Product particle size ( $\mu\text{m}$ )	0.08 to 2.0	0.005 to 0.2	0.001 to 0.01	0.0001 to 0.001
Retained compounds	Very small suspended particles, some colloids, most bacteria	Organic compounds > 1000 Da, pyrogens, viruses, bacteria, colloids	Organic compounds > 200 Da, some dissolved solids (i.e. multivalent ions)	Ions, Organic compounds >100 MW
Operating pressure, psi	1 to 15	30 to 100	80 to 125	$\geq 1,000$

## 2.6 Occurrence of Pharmaceuticals and personal care products (PPCPs) in wastewater

The occurrence of pharmaceutically active substances and their metabolites and also personal care products (PPCPs) in the environment has become an important issue in the last few years. These compounds along with their metabolites, which can be even more harmful than the original compounds, are continuously released in the environment, mainly through disposal of unused or expired drugs or directly from pharmaceutical discharges [37].

Thousands of tons of pharmaceuticals are used yearly with different purposes, such as prevention, diagnosis, care, and mitigation of diseases or improve the state of health, the

same quantity or more consumed from PPCPs which include analgesics, fragrances, sun screen, shampoos and cosmetics[38].

Public awareness and concern has grown significantly over the past three decades and has brought this issue to the forefront in the water quality area[37].

Pharmaceuticals are generally excreted after being partially or completely converted to metabolites with enhanced solubility in water, but a significant quantity of the parent drug may also be excreted unchanged [38].

Most of these compounds come either from domestic sewage or from hospitals, or industrial discharges and enter municipal Wastewater Treatment Plants (WWTPs). Their removal efficiencies are influenced by the chemical properties of specific compounds, by microbial activity and environmental conditions [40-42]

Recent studies have clearly shown that the elimination of pharmaceutically active compounds (PhACs) in municipal WWTPs is often incomplete [42].

With efficiencies ranging between 60% and 90% for a variety of polar compounds[44-45]

A major factor influencing the efficiency of pollutants removal from water is their ability to interact with solid particles, both natural (clay, sediments) or added to the medium (active carbon, coagulants) and with microorganisms, because this facilitates their removal by physical– chemical (settling, flotation) or biological processes (biodegradation). However, compounds with low adsorption coefficients tend to remain in the aqueous phase, which favors their mobility through the WWTP into the receiving environment [45]

### **2.6.1 Analytical methods**

The presence of pharmaceuticals and personal care products (PPCPs) at trace levels( $\text{ngL}^{-1}$ ) and in complex water matrices, such as wastewater and surface water, making their analysis difficult [46].

Currently, no standardized analytical methods are available for the analysis of pharmaceuticals and organic micropollutants in general in environmental waters, because these pharmaceuticals represent structurally diverse classes of compounds, and owing to the diversity of physic-chemical properties, so different analytical methods have been used for identification and quantification of these chemicals in water samples [48].

The most common sample isolation and pre-concentration technique is solid phase extraction (SPE) [49].

SPE also used for cleanup of pharmaceuticals in water samples [50].

Variations of SPE include solid phase micro-extraction (SPME) and various on-line and automated SPE techniques [51].

### **2.6.2A Antibiotic pharmaceuticals in wastewater**

Antibiotics are a class of naturally-occurring, semi-synthetic and/or chemically synthetic compounds with antimicrobial activity. They are widely used in human and veterinary medicine to treat and prevent diseases [51-52].

The presence of antibiotics in the aquatic environment has created two concerns. The immediate concern is the potential toxicity of these compounds to aquatic organisms and humans through drinking water. In addition, there is growing concern that a release of antibiotics to the environment might contribute to the emergence of strains of disease-causing bacteria that are resistant to high doses of these drugs [53-54].

Antibiotics as an important group of PhACs, have been first produced in early 1940s and widely used in fighting against infectious bacteria and fungi [55]

Researchers have shown that several classes of antibiotics and PPCPs are present in domestic effluents and aquatic environments [56-57].

Since they are often not fully assimilated by humans and animals during treatment [58].

In addition, most of them show a recalcitrant behavior and are not easily removed from wastewaters in sewage treatment plants (STPs) [60]

The types and concentrations of antibiotics in the environment vary among areas and countries, depending on antibiotic consumption and use patterns. [57].

In some industrialized countries, WWTP effluents containing antibiotics used in human medicine are the major sources of antibiotics in the aquatic environment [61] Antibiotic occurrence in aquatic systems is also affected by their chemical stability and partition characteristics [62].

For example, sulfonamides exhibit high solubility and chemical stability in water, whereas macrolides tend to be hydrolyzed or sorbed to soil and sediments [63].

quinolones are susceptible to photodegradation[64],and are also adsorbed in sediments[65]. And tetracyclines have a high affinity for soil organic matter through cation bridging and cation exchange. [66]

In recent years, the incidence of antibiotic resistant bacteria has increased and many people believe the increase is due to the use of antibiotics. Furthermore, the presence of antibiotics in wastewaters has increased in recent years and their abatement will be a challenge in the near future [66].

### **2.6.3 Method of treatment**

Albeit pharmaceuticals residue and their metabolites are usually detectable in the environment at trace levels, the low concentration level ( $\text{ngL}^{-1}$  -  $\mu\text{gL}^{-1}$ ) can induce toxic effects, as in the cases of antibiotic and steroids that cause resistance in natural bacterial populations or endocrine disruption effects [72].

Generally the methods used for wastewater treatment are:-

(a) Biodegradation: biological degradation can take place in wastewater by means of aerobic/anaerobic microbial degradation of the drug substance leading to reduction of parent compounds and or their metabolites during wastewater treatment [73].

The microbes include bacteria, yeasts, fungi, protozoa, so some of these organisms have the ability to degrade some of most hazards and recalcitrant chemicals [74]

(b) Deconjugation: pharmaceuticals compounds are often metabolized in the liver, and as a consequence glucuronide and sulfate conjugates of the parent drug are excreted, deconjugation in domestic wastewater and within sewage treatment plants (STPs), for organic compounds such as steroid hormones will occur due to the large amounts of  $\beta$ -glucuronidase enzyme present, glucuronide and sulfate conjugates of drug compounds will be degraded by the same process, the effect will increase the excreted contribution of the active drugs to sewage and effluents.

(c) Partitioning: partitioning between the aqueous and organic biomass phase is considered the key component in determining the ultimate concentration of organic pollutants.

Compounds with high  $\log K_{o/w}$  (lipophilic molecules) values are known to sorb to sludge, while substances with lower values are more likely to stay in the aquatic phase, depending on the individual compound, and substances sorbing to solids may also be remobilized if they are not strongly bound [73].

(d) Removal during sludge treatment: drugs may also be degraded by a biotic process (Hydrolysis) during sewage treatment process. Many pharmaceutical compounds are not thermally stable, and so might be expected to break down during processes such as composting due to heat as well as chemical and biodegradation [73].

(e) Photodegradation: several pharmaceutical compounds have shown to degrade due to the action of sunlight, some pharmaceuticals compounds such as diclofenac which is analgesic/anti-inflammatory drug, has been shown to degrade in aquatic environment due to ultraviolet (UV) light [73].

As a consequence, removal of pharmaceutical substance before entering the aquatic environment as well as for water reuse is very important. Furthermore, to ensure compliance with future discharge requirements, upgrading of existing water and wastewater treatment plants and implementation of new technologies are considered as the next steps in improvement of wastewater treatment [67].

This thesis reports on the efficiency of advanced technology such as membrane filtration technology for removal of selected pharmaceuticals, amoxicillin trihydrate and cefuroxime axetil, at the wastewater treatment plant at Al-Quds University which includes ultrafiltration (hollow fiber and spiral wound) and reverse osmosis.

This study reports their adsorption by activated carbon and micelle-clay filters. The micelle-clay composites that was used are positively charged, have a large surface area and include large hydrophobic domains. It was shown by X-ray diffraction, electron microscopy and adsorption experiments that the characteristics of the micelle-clay complexes are different from those of organo-clay complexes which are formed by adsorption of the same organic ODTMA (octadecyltrimethylammonium) cation as monomers [76].

## **Chapter three**

# **Experimental**



## Chapter Three:

---

### Experimental:

This chapter consists of three parts: part one describes the instruments used, part two documents the chemicals and reagents utilized, the last part deals with the methods implemented.

### 3.1 Part one

#### 3.1.1 Instrumentation

##### 3.1.1.1 High Performance Liquid Chromatography

High Pressure Liquid Chromatography (HPLC-PDA) system consists of an alliance 2695 HPLC from (Waters), and a waters Micromass® Masslynx™ detector with Photo diode array (PDA) (Waters 2996). Data acquisition and control were carried out using Empower™ software (Waters). Analytes were separated on a 4.6 mm x150 mm C18 XBridge® column (5 µm particle size) used in conjunction with a 4.6mmx20 µmXBridge™ C18 guard column. Microfilter was used with 0.45µm (Acrodisc® GHP, Waters).

##### 3.1.1.2 UV-Spectrophotometer

The concentrations of the drugs in samples were determined spectrophotometrically (UV-spectrophotometer, Model: UV-1601, Shimadzu, Japan) by monitoring the absorbance at  $\lambda_{max}$  for each drug.

##### 3.1.1.3 pH meter

pH values were recorded on pH meter( model HM-30G: TOA electronics™).

##### 3.1.1.4 Centrifuge and Shaker

Labofuge®200 Centrifuge was used (230 V 50/60 Hz. CAT. No. 284811, made in Germany). Some of pharmaceuticals solutions were shaken with an electronic shaker (Bigbill shaker, Model No.: M49120-26, 220-240 V 50\60 Hz.) at 250 rpm.

### **3.1.1.5 Description of Wastewater Treatment Plant (WWTP)**

The wastewater treatment plant (WWTP) at Al-Quds University collects a mixture of black, gray, and storm water. The treatment plant consists of a primary treatment (two stage primary settling basin), and a secondary treatment (activated sludge with a hydraulic retention time of 16-20 hours, coagulation and chlorination) . Then, the secondary effluent is introduced to the sand filter before entering the ultra filtration membrane (Hollow fiber and Spiral wound). After the ultra filtration process, the effluent is subjected to activated carbon column followed by a reverse osmosis (advanced treatment). Then, a blend of all effluents is used for irrigation. The ultra filtration process is made of two small scale membrane treatment plants with a capacity of 12 m<sup>3</sup> /day. The first UF unit is equipped with 2 x 4 inch pressure vessels with pressure resistance up to 150 psi. Each vessel holds two separation membranes (spiral wound with 20 kD cutoffs which is equivalent to 0.01 micron separation rate). The designed permeate capacity of the system is 0.5-0.8 m<sup>3</sup>/h. This Membrane can remove bacteria, suspended solids, turbidity agents, oil, and emulsions. The second unit is equipped with two pressure vessels made from Vendor (AST technologies, model number 8000 WW 1000-2M) that houses the hollow fiber membranes with 100 kD cutoff (Vendor, AST technologies, Model no. 8000- WWOUT-IN-8080). The two units are designed to deliver 1 .5m<sup>3</sup>/h. The reverse osmosis (RO) membranes are made from thin film polyamide which consists of 1 x 4 inch pressure vessel made from composite material with pressure resistance up to 400 psi. The vessel holds two 4 inches special separation membranes (manufactured in thin film polyamide with pH range 1-11 models BW30-4040 by DOW Film Tec.). Membrane anti-scalent (Product NCS-106-FG, made of phosphate in water with active ingredient of phosphoric acid disodium salt) are continuously dosed to the RO feed at concentration of 4 ppm in order to prevent deposition of divalent ions. The system is designed to remove major ions and heavy metals. The designed RO permeate capacity of the system is 0.45- 0.5 m<sup>3</sup>/h [67].

## **3.2 Part two**

### **3.2.1 Chemicals and Reagents**

#### **3.2.1 Chemicals and Reagents**

Pure standards of amoxicillin trihydrate, and cefuroximaxetil (> 99%) were obtained as a gift from Beit Jalah pharmaceutical company (Palestine). Acetonitrile, methanol and water HPLC grade purchased from Sigma Aldrich, charcoal activated fine powder with particle size ( $\leq 60.0$  micron), charcoal activated granules with particle size ( $\leq 700.0$ micron) were purchased from Sigma Aldrich, and octadecyltrimethylammonium (ODTMA) was purchased from Sigma chemical company[68].

C<sub>18</sub> (5g) cartridges 6cc single use for general laboratory use were purchased form Waters company (Milford, MA, USA)

## **3.3 Part three**

### **3.3.1.Methods(Amoxicillin Trihydrate , CefuroximAxetil)**

#### **3.3.1.1 Calibration curves using the solid phase cartridge**

(a) **Stock solution:** Stock solution was prepared by dissolving amoxicillin trihydrate, cefuroxim axetil standards in water to a concentration of  $1000 \text{ mg L}^{-1}$  for the use in section (b).

#### **(b) Calibration curves using the solid phase cartridge**

The C<sub>18</sub> cartridges were preconditioned by passing first 10 mL of water through the cartridge and then 10 mL of methanol. The cartridges were then air dried. Several solutions of amoxicillin trihydrate and cefuroxim axetil with different concentrations (1.0, 5.0, 10.0, 20.0, 50.0, 100.0, 200.0 and 500.0  $\text{mg L}^{-1}$ ) were prepared. 10 mL of each of these solutions was passed through the cartridge. The adsorbed amoxicillin trihydrate and cefuroxim axetil was eluted from the adsorbent of the cartridge using 10 mL of methanol. Afterwards, 20  $\mu\text{l}$  of the eluate was injected into the HPLC and analyzed using the HPLC conditions for amoxicillin trihydrate and cefuroxim axetil. Peak areas vs. concentration of amoxicillin trihydrate and cefuroxim axetil was then plotted, and correlation coefficient of the plots were recorded.

### 3.3.1.2 Efficiency of the wastewater treatment plant (WWTP) of Al-Quds University for removal of amoxicillin trihydrate and cefuroxim axetil

The efficiency of different membranes (hollow fiber (HF-UF), spiral wound (SW-UF), activated carbon and reverse osmosis (RO) membranes, for the removal of amoxicillin trihydrate and cefuroxim axetil from wastewater was studied by spiking amoxicillin trihydrate and cefuroxim axetil in the storage tank of the wastewater treatment plant at a concentration of  $20 \text{ mg L}^{-1}$  (by dissolving 10 g of amoxicillin trihydrate and cefuroxim axetil in the storage tank containing 500 liters of activated sludge wastewater). Samples were taken from the following points of the WWTP: (1) storage tank (before running wastewater treatment plant) (2), (3), and (4) feed-, brine- and product-points of the HF-UF membrane, respectively (5) and (6) concentrated -, and permeated-UF point of the HF- SW membrane, respectively (7) activated carbon point, and (8) reverse osmosis point. These sampling points are shown in (Figure 3.1). These samples were treated using SPE C18 cartridge as follows: 10 mL of sample was loaded into the C18 cartridge, and allowed to pass through the cartridge by effect of gravity. amoxicillin trihydrate and cefuroxim axetil adsorbed on the C18 cartridge was then eluted using 10 mL of methanol. 20  $\mu\text{L}$  of the eluted solution was injected into the HPLC, and analyzed using the HPLC conditions for amoxicillin trihydrate and cefuroxim axetil methods of analysis.

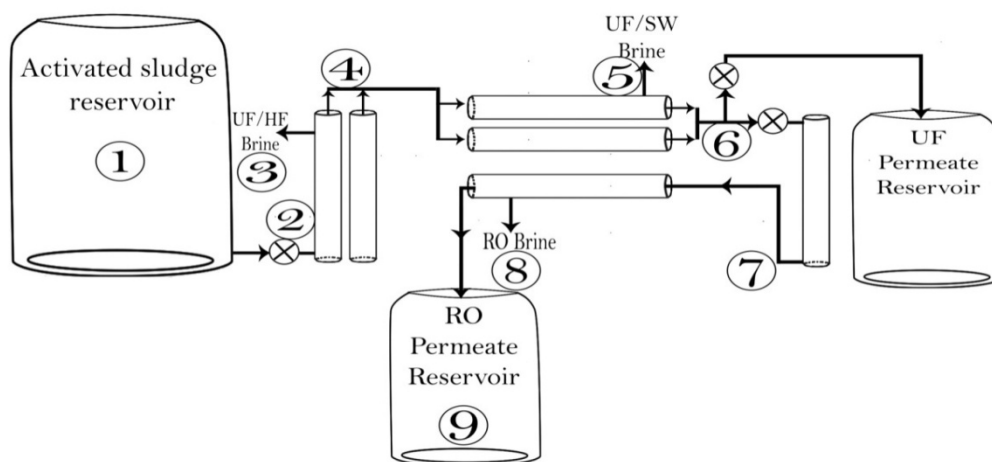
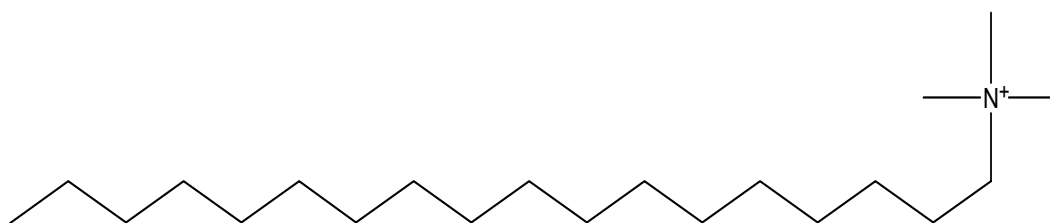

**Fig. 3.1** Flow diagram showing the process of wastewater treatment plant which consists of HF-UF filters (hollow fiber) and SW-UF (spiral wound), activated carbon and RO filters. Sampling locations are indicated by numbers.

### 3.3.1.3 Micelle-clay complex preparation

The micelle–clay complex was prepared by stirring 12mM of ODTMA with 10g/L clay for 72h at 37 c. Suspensions were centrifuged for 20 min at 15 000 g, supernatants were discarded, and the complex was lyophilized.

The obtained complex by virtue of its positive charge, and hydrophobic region is capable of efficiently binding negatively charged organic molecules [77-79]



Figuer3.2: OctaDecylTrimethyl Ammonium (ODTMA)

### 3.3.1.4 Adsorption studies onto micelle-clay complex and charcoal

#### 3.3.1.4.1 Calibration curves

**(b) Stock solution:** Stock solution was prepared by dissolving amoxicillin trihydrate, cefuroxim axetil standards in water to a concentration of 1000 mg L<sup>-1</sup> for the use in (b).

**(b) Calibration curves:** The following diluted solutions were prepared from the stock solution of amoxicillin trihydrate and cefuroxim axetil(0.5,1.0,50,100,200,300,400, 500,800, 1000.0 mg L<sup>-1</sup>) were prepared.

The absorption of each solution of amoxicillin trihydrate and cefuroxim axetil was determined using UV-spectrophotometer at ( $\lambda$  max)

#### **3.3.1.4.2. Batch adsorption isotherms**

Equilibrium relationships between adsorbents (micelle-clay complex and activated charcoal) and adsorbate (amoxicillin trihydrate, cefuroxim axetil) were described by adsorption isotherms, by studying the percentage of adsorbate removal occurred by both adsorbents (micelle-clay complex and activated charcoal) at different concentrations (100,200,300,400,500 mg L<sup>-1</sup>) prepared in distilled water pH 8.2 adjusted by 1M NaOH.

The following procedure was applied: 100 mL from each solution was transferred to 200 mL Erlenmeyer flask, 0.5 g of the micelle-clay complex or activated charcoal was added to the flask. Then the flask was placed on the shaker machine for 180 minutes. Afterwards, each sample was centrifuged for 5 minutes, and filtered using 0.45µm filter.

A kinetic study of the extent of adsorption was further determined by introducing 100 ml of 100 mg L<sup>-1</sup> amoxicillin trihydrate and cefuroxime axetil solution in 250 –ml flasks containing 0.5 g of either micelle-clay or charcoal and determining the amoxicillin trihydrate and cefuroxime axetil remaining time by time.

The absorption of each solution of amoxicillin trihydrate and cefuroxim axetil was determined using UV-spectrophotometer at ( $\lambda$  max) of 273 nm and 278 nm for amoxicillin trihydrate and cefuroxim axetil respectively.

#### **3.3.1.5. Column experiments:**

Column filter experiments were performed with 25/1 (w/w) mixtures of quartz sand and ODTMA-clay complex (20 cm layer) in a column of 25 cm length and 5 cm diameter prepared by mixing 4 g of micelle-clay complex and 96 g sand. The bottom of the column was covered with 3 cm layer of quartz sand. Quartz sand was thoroughly washed by distilled water and dried at 105 °C for 24h prior its use. Wool layer of 2 cm was placed at the bottom of the column to prevent clogging. 1000 mL of 100 mg L<sup>-1</sup> amoxicillin trihydrate solution was passed through the column at a fixed flow rate of 2 mL min<sup>-1</sup>.

For cefuroxim axetil 1000 mL of 50 mg L<sup>-1</sup> cefuroxim axetil solution was passed through the column at a fixed flow rate of 2 mL min<sup>-1</sup>. In certain experiments the columns included 4 g of activated carbon (GAC) mixed with sand as above.

Eluted fractions of 100 mL (each) were collected at chosen times, and analyzed for amoxicillin trihydrate and cefuroxim axetil concentration using UV-spectrophotometer at ( $\lambda$  max)of 273 nm 278nm.

All experiments described were conducted in triplicates.

## **Chapter Four**

# **Results and discussion**



## Chapter Four:

---

### Results and discussion:

#### 4.1 Amoxicillin Trihydrate

##### 4.1.1 Introduction

amoxicillin trihydrate is a semi-synthetic  $\beta$ -lactam antibiotic (Figure 4.1), the only phenolic penicillin which is used as an antibacterial drug [66]

amoxicillin trihydrate is a white or almost white, crystalline powder with a molecular weight of 419.4. It is slightly soluble in water. It is frequently used as an antibiotic to treat many infections [70].

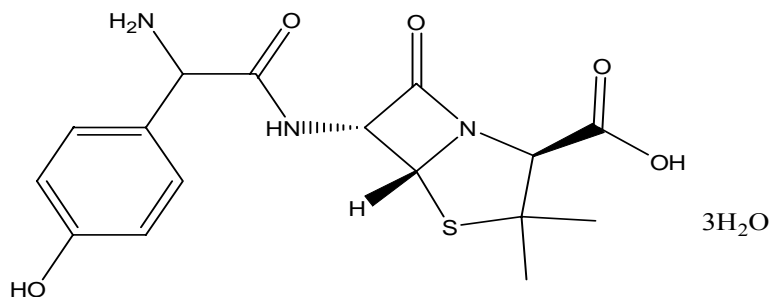

Figure 4.1. Structure of amoxicillin trihydrate

##### 4.1.2 Calibration curve for Amoxicillin Trihydrate using solid phase extraction cartridge (SPE)

The calibration curve was obtained by plotting peak area versus concentration (in  $\text{mgL}^{-1}$ ) and is displayed in (Figure 4.2) (seven data points) for amoxicillin trihydrate. The plot showed excellent linearity with a correlation coefficient ( $R^2$ ) of 0.999. This indicates that the method used is quite reliable.

##### 4.1.2.1 HPLC conditions for analysis of Amoxicillin Trihydrate

C18 column 250mm\*4.6mm, wavelength = 273 nm, Flow rate = 1.0 mL/min, mobile phase: 75% of water and 25% acetonitrile.

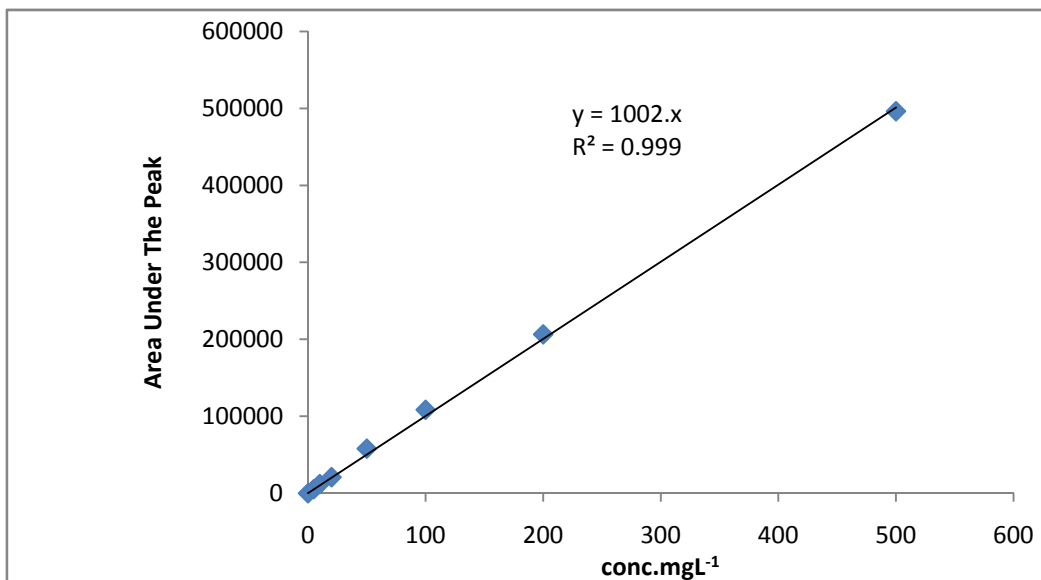

**Figure 4.2: Calibration curve by using SPE for amoxicillin trihydrate.**

#### **4.1.3 Efficiency of the wastewater treatment plant (WWTP) at Al-Quds University for the removal of Amoxicillin Trihydrate**

The efficiency of the wastewater treatment plant (WWTP) at Al-Quds University for amoxicillin trihydrate removal was studied. The result demonstrated that amoxicillin trihydrate was 58.93% removed at the hollow fiber stage (UF-HF), while about 90.33% of amoxicillin trihydrate was removed at the spiral wound (SW) stage, (Tables 4.1 and 4.2). At the activated carbon adsorbent point of the wastewater treatment plant, 96.47% of amoxicillin trihydrate was removed. The results also indicated that complete removal (100%) of amoxicillin trihydrate was achieved after passing through the reverse osmosis membrane (RO) (Figures 4.3 and 4.4)

**Table 4.1: Removal of amoxicillin trihydrate through the hollow fiber (UF-HF), spiral wound (UF-SW), activated carbon adsorbent and reverse osmosis from the wastewater treatment plant at Al-Quds university.**

No.	Sample location name		Conc. of amoxicillin trihydrate (mgL <sup>-1</sup> )	Conc. of amoxicillin trihydrate (mgL <sup>-1</sup> )	Conc. of amoxicillin trihydrate (mgL <sup>-1</sup> )
			First trial	Second trial	Third trial
1	Blank (before addition of amoxicillin trihydrate)		0	0	0
2	The initial concentration of amoxicillin trihydrate in storage tank (after addition of amoxicillin trihydrate)		19.1	18.5	19.5
3	HF-UF	Feed point	18	17.6	18
		Brine point	6.03	11.85	12.33
		Product point	11.97	5.75	5.67
4	HF-SW	Concentrated UF point	9.69	4.27	3.72
		Permeated UF point	2.10	1.48	1.95
5	Activated carbon point		1.19	0.41	0.41
6	Reverse osmosis (RO)	Permeated RO point	0.0	0.0	0.0

**Table 4.2: Accumulative % removal of amoxicillin trihydrate.**

Trial No.	Hollow fiber (HF)	Spiral wound (SW)	Activated carbon	Reverse osmosis (RO)
1	37.00%	89.00%	93.76%	100.00%
2	68.90%	92.00%	97.76%	100.00%
3	70.90%	90.00%	97.90%	100.00%
Average	58.93%	90.33%	96.47%	100.00%
SD	0.19	0.02	0.02	0.00

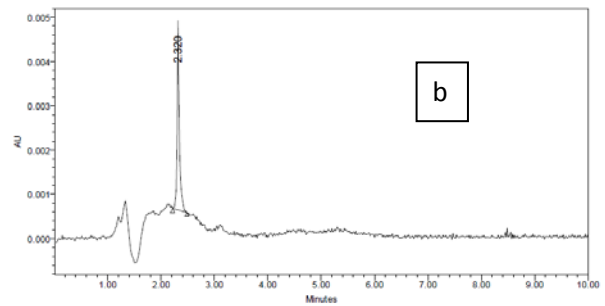
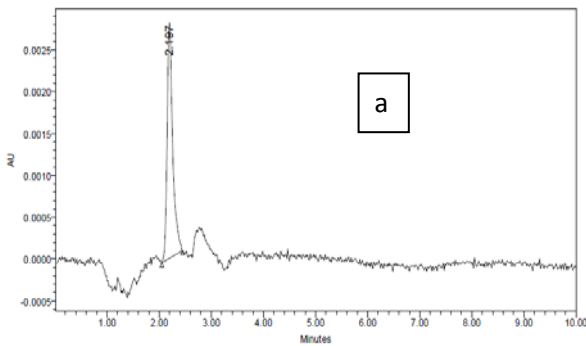

**Figure 4.3: Chromatograms showing the initial concentration of amoxicillin trihydrate (a) and after running the HF-UF point (b).**

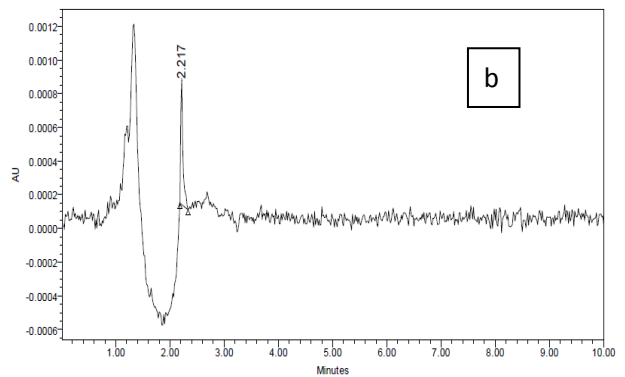
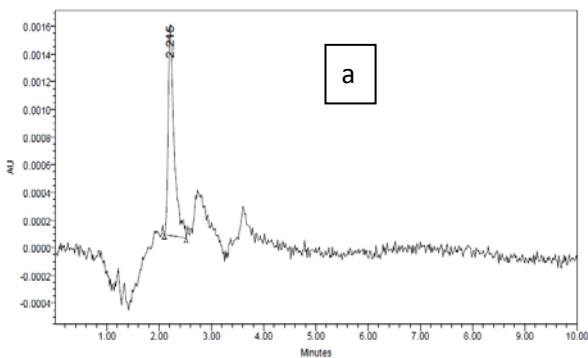

**Figure 4.4: Concentration of amoxicillin trihydrate before and after running the SW-UF point, (a,b), Respectively .**

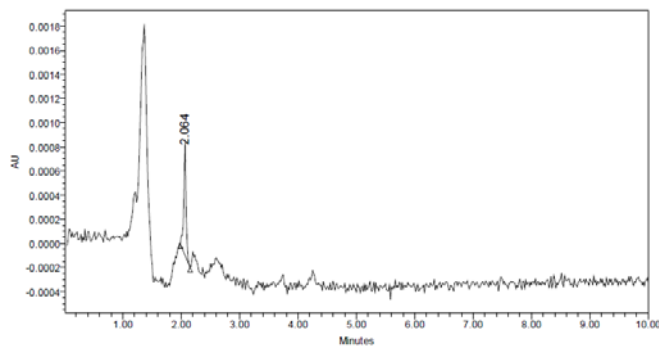

**Figure 4.5: Chromatogram showing the concentration of amoxicillin trihydrate after running activated charcoal adsorbent point .**

#### 4.1.4. Calibration curve for Amoxicillin Trihydrate using UV-visible spectrophotometer

The calibration curve was obtained by plotting absorption versus concentration of amoxicillin trihydrate and is displayed in (Figure4.6) (8 data points). The Figure shows excellent linearity in the range 0.5-1000 mg L<sup>-1</sup> with correlation coefficient (R<sup>2</sup>) of 0.999, this indicates that the method used is linear.

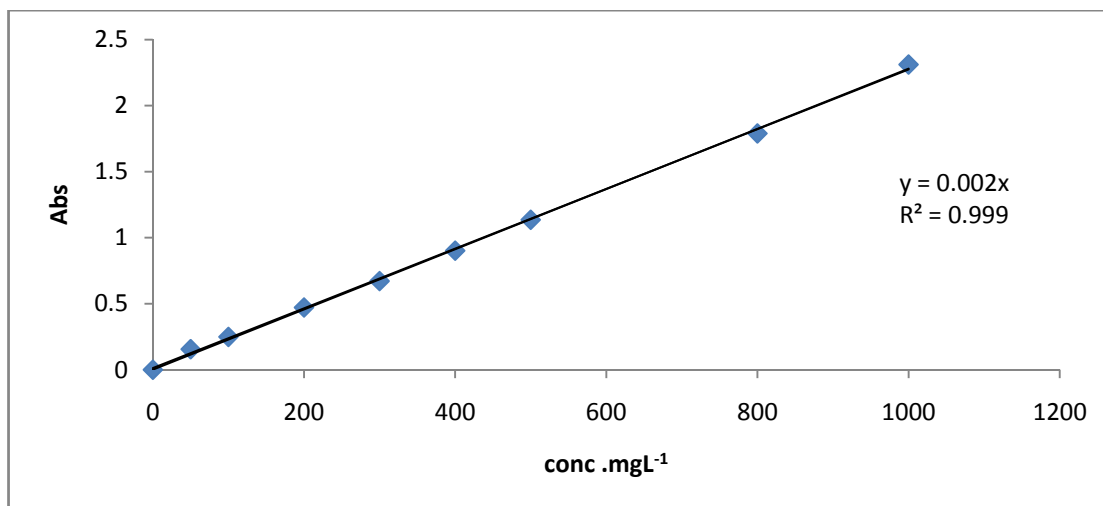

Figure 4.6: calibration curve of amoxicillin trihydrate

#### 4.1.5 Adsorption studies of Amoxicillin Trihydrate on a micelle-clay complex (ODTMA) and activated charcoal.

Adsorption mechanism depends on the physicochemical properties of the pharmaceutical and the aquifer media properties. Adsorption of amoxicillin trihydrate onto a micelle-clay complex and charcoal adsorbents was investigated and described in this section.

##### 4.1.5.1 Adsorption of Amoxicillin Trihydrate on a micelle-clay complex (ODTMA) and activated charcoal.

amoxicillin trihydrate removal by a micelle-clay complex and activated charcoal were studied. Samples were taken at different time intervals (0 -180 minutes). The results revealed that activated charcoal was effective for the removal of amoxicillin trihydrate from spiked samples (100 mg L<sup>-1</sup>) at pH = 8.2. The removal was about 98.5% and was achieved after three hours.

The capacity of the micelle-clay complex and activated charcoal towards adsorption of amoxicillin trihydrate was quite comparable. The results showed that the adsorption of amoxicillin trihydrate on the micelle-clay complex is faster when compared to that on the activated charcoal (about 81.6% of amoxicillin trihydrate was removed in the first 5 minutes while only 50.2% of amoxicillin trihydrate was removed by the activated charcoal).

**Table 4.3: Percentage removal of amoxicillin trihydrate by micelle-clay complex (ODTMA) at pH 8.2**

Time(minutes)	Abs	Conc.( mg L <sup>-1</sup> )	Mass(mg)	%Removal
0	0.249	100	10	0
5	0.042	18.4	1.84	81.6
10	0.040	17.3	1.73	82.7
20	0.026	11.5	1.15	88.5
30	0.023	9.8	0.98	90.2
40	0.021	9	0.9	91
50	0.017	7.2	0.72	92.8
60	0.016	6.8	0.68	93.2
80	0.013	5.7	0.57	94.3
100	0.012	5	0.5	95
120	0.008	3.5	0.35	96.5
150	0.007	3	0.3	97
180	0.006	2.48	0.248	97.52

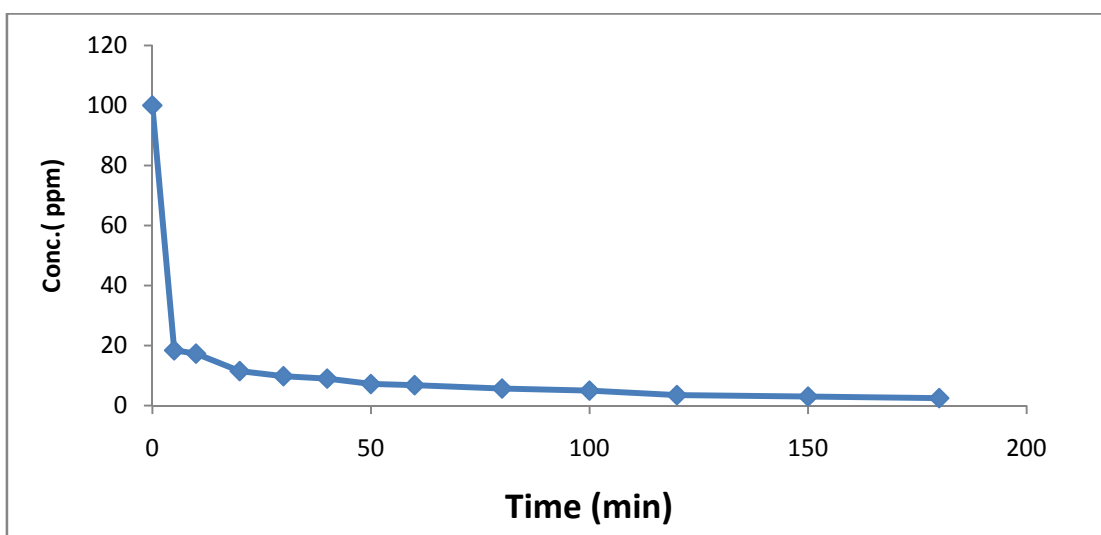

**Figure 4.7: Adsorption of amoxicillin trihydrate by micelle- clay complex (ODTMA) at pH 8.2**

**Table 4.4: Percentage removal of amoxicillin trihydrate by activated charcoal.**

Time(Minutes)	Abs	Conc.( mg L <sup>-1</sup> )	Mass(mg)	% Removal
0	0.249	100	10	0
5	0.115	49.8	4.98	50.2
10	0.102	44.4	4.44	55.6
20	0.091	39.6	3.96	60.4
30	0.049	21.5	2.15	78.5
40	0.033	14.4	1.44	85.6
50	0.022	9.7	0.97	90.3
60	0.017	7.5	0.75	92.5
80	0.015	6.4	0.64	93.6
100	0.013	5.5	0.55	94.5
120	0.007	3.2	0.32	96.8
150	0.005	2.1	0.21	97.9
180	0.003	1.5	0.15	98.5

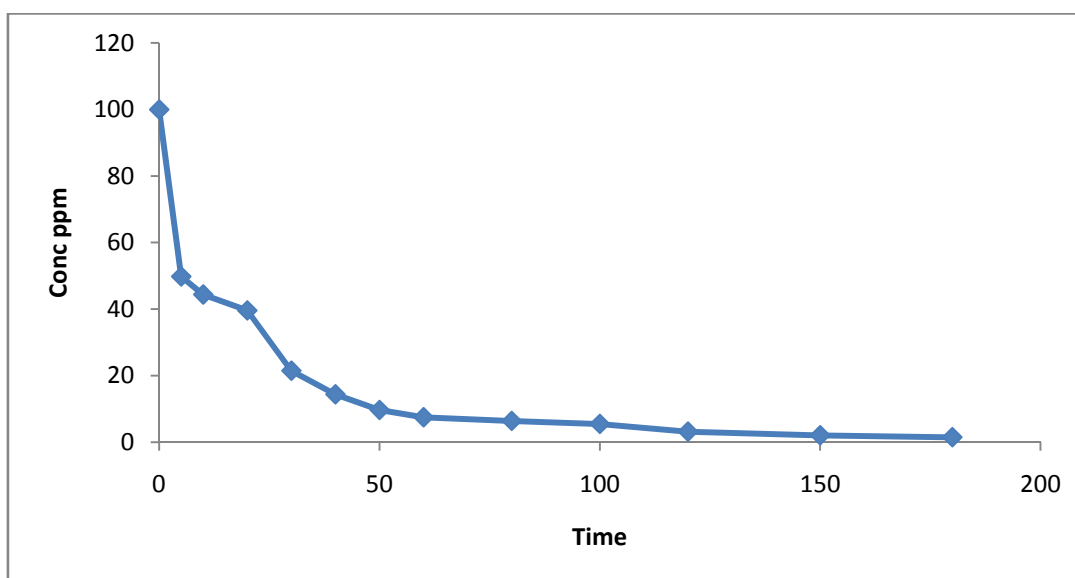

**Figure 4.8: Adsorption of amoxicillin trihydrate by charcoal at pH 8.2**

#### 4.1.5.2 Analysis Of Adsorption Isotherms

Equilibrium relationships between adsorbents (micelle-clay complex and charcoal) and adsorbate (i.e amoxicillin trihydrate) are described by adsorption isotherms. The most common model for adsorption process is Langmuir adsorption isotherms which consider the most widely used modeling for equilibrium data and determination of the adsorption capacity [80]

It is a linear form and represented by the following equation:

$$C_e/Q_e = 1/(K Q_{max}) + C_e/Q_{max} \dots \dots \dots \text{Eq. (1)}$$

Where:  $C_e$ : equilibrium concentration of amoxicillin trihydrate ( $\text{mg L}^{-1}$ ).

$Q_e$ : the equilibrium mass of the adsorbed amoxicillin trihydrate per gram of complex or activated carbon ( $\text{mg.g}^{-1}$ )

$K$ : Langmuir binding constant  $k$  ( $\text{L mg}^{-1}$ )

$Q_{max}$ : maximum mass of amoxicillin trihydrate removed per gram of complex ( $\text{mg.g}^{-1}$ )

For this study the adsorption of amoxicillin trihydrate of five concentrations (100, 200, 300, 400, and 500  $\text{mg L}^{-1}$ ) on the micelle-clay complex and activated charcoal were studied, then  $C_e$ , and  $Q_e$  were calculated as in (Tables 4.5 and 4.6).  $C_e/Q_e$  vs.  $C_e$  was plotted for amoxicillin trihydrate adsorbed onto both micelle-clay complex and activated charcoal (Figure 4.9).

**Table 4.5: Concentrations in equilibrium obtained for adsorption test of amoxicillin trihydrate onto the adsorbent micelle-clay .( pH 8.2 and 25°C)**

Conc ( $\text{mg L}^{-1}$ )	Mass (mg) (Initial)	Abs (T=180 min)	Conc (T=180) ( $C_e$ ) ( $\text{mg L}^{-1}$ )	Mass (mg) (Final)	M Initial- M Final	Q=(M Initial- M Final)/0.5	$C_e/Q_e$
100	10	0.006	2.47	0.247	9.753	19.506	0.13
200	20	0.020	9.9	0.99	19.01	38.02	0.26
300	30	0.057	28.47	2.847	27.153	54.306	0.52
400	40	0.141	70.6	7.06	32.94	65.88	1.07
500	50	0.209	104.55	10.455	39.545	79.09	1.32

**Table 4.6: Concentrations in equilibrium obtained for adsorption test of amoxicillin trihydrate onto the adsorbent activated charcoal .( pH 8.2 and 25°C)**

Conc ( $\text{mg L}^{-1}$ )	Mass(mg) (Initial)	Abs (T=180 min)	Conc (T=180) ( $C_e$ ) ( $\text{mg L}^{-1}$ )	Mass (mg) (Final)	M Initial- M Final	Q=(M Initial- M Final)/0.5	$C_e/Q_e$
100	10	0.003	1.5	0.15	9.85	19.7	0.08
200	20	0.007	3.46	0.346	19.654	39.308	0.09
300	30	0.021	10.29	1.029	28.971	57.942	0.18
400	40	0.065	32.52	3.252	36.748	73.496	0.44
500	50	0.136	68.15	6.815	43.185	86.37	0.79



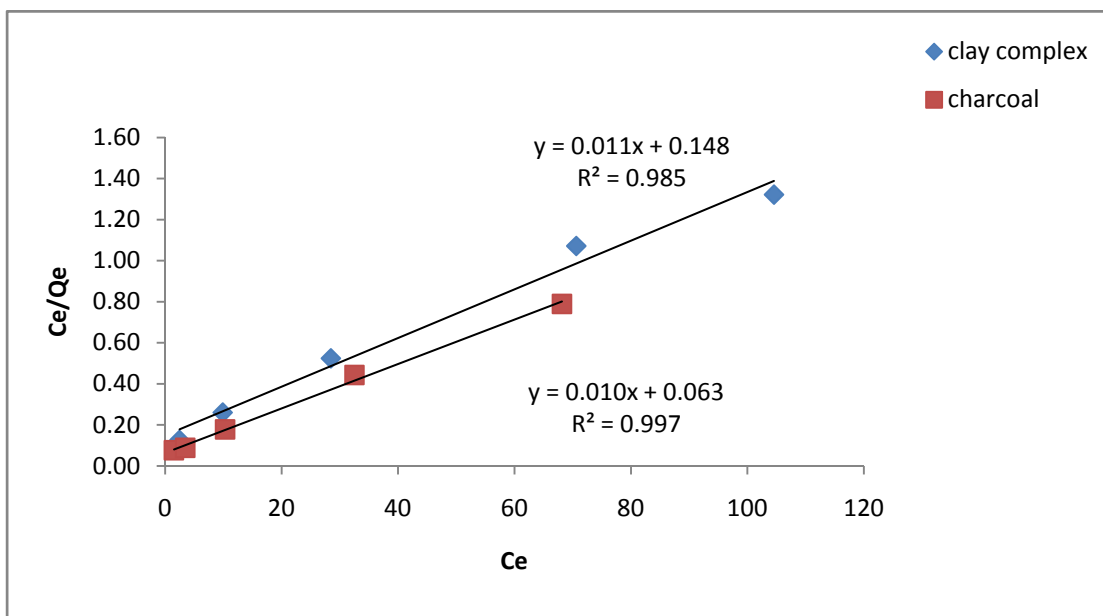

**Figure. 4.9:** Langmuir isotherms for the removal of amoxicillin trihydrate by micelle-clay complex (◆) and by activated charcoal (■) .(pH 8.2, 25°C) .

The two parameters  $Q_{\max}$  and  $K$  values for adsorption of amoxicillin trihydrate on micelle-clay complex and activated charcoal can be calculated from the slopes and y-intercepts of the equations obtained from the plots

( $Q_{\max} = \text{slope}^{-1}$ ,  $K = (\text{y-intercept})^{-1}(Q_{\max})^{-1}$ ). (Table 4-7) shows the values for  $Q_{\max}$  and  $k$  for amoxicillin trihydrate adsorbed on both micelle-clay complex and activated charcoal.

**Table4.7: Langmuir adsorption parameters ( $k$  and  $Q_{\max}$ ) and the correlation coefficient ( $R^2$ ) values obtained from the adsorption of amoxicillin trihydrate on both adsorbents, a micelle-clay complex and activated charcoal.**

Pharmaceutical	Adsorbents	Langmuir		
		K (L/mg)	$Q_{\max}$ (mg/g)	$R^2$
amoxicillin trihydrate	micell- clay complex	$0.229 \pm 0.001$	$90.91 \pm 0.86$	0.985
	Charcoal	$0.158 \pm 0.001$	$100 \pm 0.35$	0.997

\* Results of  $K$  and  $Q_{\max}$  are repeated as value  $\pm$  SD; SD: standard deviation of three replicates

The results demonstrated that, activated charcoal have more efficiency for the removal of amoxicillin trihydrate as both  $Q_{\max}$  are comparable ( $90.91$  mg of amoxicillin trihydrate per

gram of complex, and 100 mg of amoxicillin trihydrate per gram of activated charcoal) , As shown in (Figure 4.9) the relationship between  $C_e/Q_e$  and  $C_e$  is linear for both the micelle-clay complex and activated charcoal with  $R^2$  greater than 0.98 which indicates that the adsorption of amoxicillin trihydrate onto micelle-clay and charcoal follows the Langmuir isotherm model.

#### 4.1.5.3 Column Experiments

1000 mL of amoxicillin trihydrate(100 mgL<sup>-1</sup>) were eluted in triplicate through column filters.

The results demonstrate that a filter which includes the micelle-clay complex (ODTMA)-montmorillonite is very efficient in purifying water from amoxicillin trihydrate compared to that removed by activated charcoal..

Comparing results of batch adsorption kinetics reported in Fig. 4.9 (100 mgL<sup>-1</sup> solution/0.5 g L<sup>-1</sup> adsorbent) with those of Fig. 4.10, it is evident that the flow rate used (2 mL min<sup>-1</sup>) can be suitable for the filtration of 1000 mL of 100 mgL<sup>-1</sup> amoxicillin solution, yielding a complete removal of the drug.

**Table4.8: Removal of amoxicillin trihydrate by filtration of its solution ( 100 mgL<sup>-1</sup>) through a laboratory filter, which included either a micelle-clay complex , or activated carbon mixed with excess sand at 1:25 (w/w).**

Volume Filtered (mL)	Concentration (ppm)	Column Type	Emerging concentration (ppm)	% Removal
1000	100	micelle-clay	0.5 ±0.001	99.5
1000	100	activated carbon	1±0.002	99

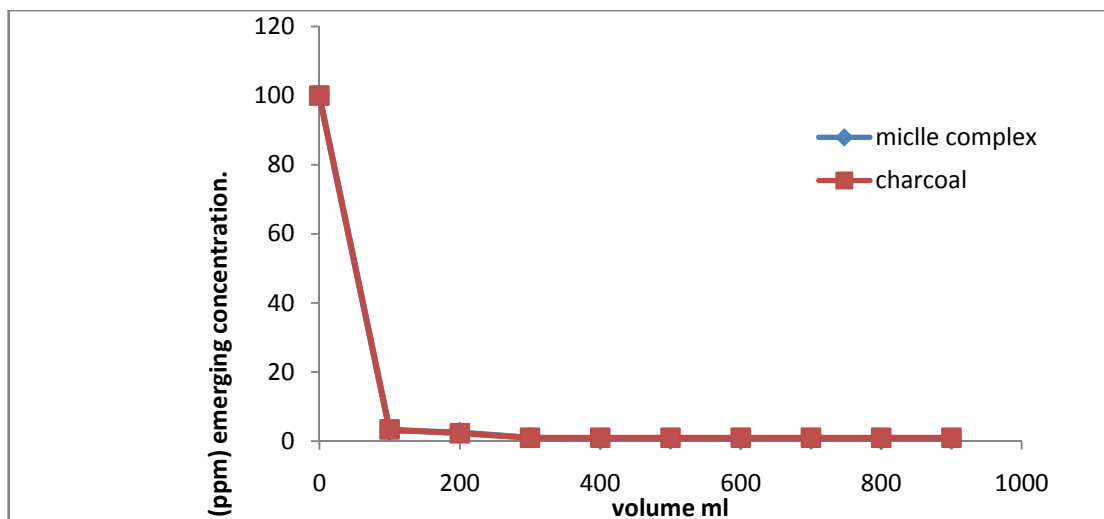

Figure 4.10. Conc. Of amoxicillin trihydrate Vs. Volume Of Samples Were Taken From micelles Clay And Charcoals Column .

## 4.2 Cefuroxime axetil

### 4.2.1 Introduction

cefuroxime axetil(CA), (RS)-1 hydroxyethyl (6R,7R)-7-[2- (2-furyl) glyoxyl-amido] -3-(hydroxymethyl -8-oxo-5- thia-1- azabicyclo[4.2.0]-oct-2-ene-2- carboxylate,72-(Z)-(O-methyl-oxime),1-acetate3- carbamate )(Figure 4.11) is a second generation oral cephalosporin antibiotic used to treat or prevent infections that are proven or strongly suspected to be caused by bacteria.

It is an acetoxyethylester prodrug of cefuroxime which is effective orally. The activity depends on in vivo hydrolysis and release of cefuroxime [75]

cefuroxim axetil is a white or almost white powder and is slightly soluble in water. [71]

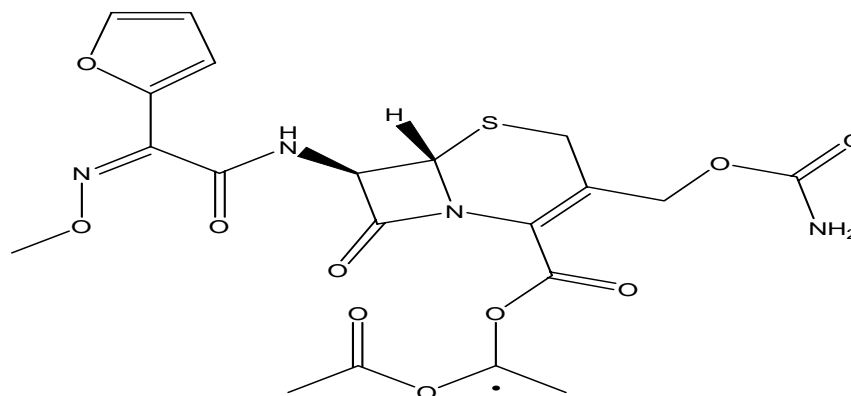

Figure 4.11. Structure of cefuroxime axetil

#### 4.2.2. Calibration curve for cefuroxime axetil using solid phase extraction cartridge (SPE)

The calibration curve was obtained by plotting peak area versus concentration (in ppm) and is displayed in (Figure 4.12) (seven data points) for cefuroxime axetil. They showed excellent linearity with correlation coefficient ( $R^2$ ) of 0.999. This indicates that the method used is quite reliable.

##### 4.2.2.1 HPLC conditions for analysis of Cefuroxime axetil

C18 column 250mm\*4.6mm, wavelength = 278 nm, Flow rate = 1.2 mL/min, mobile phase: 60% of H<sub>2</sub>O 40% acetonitrile.

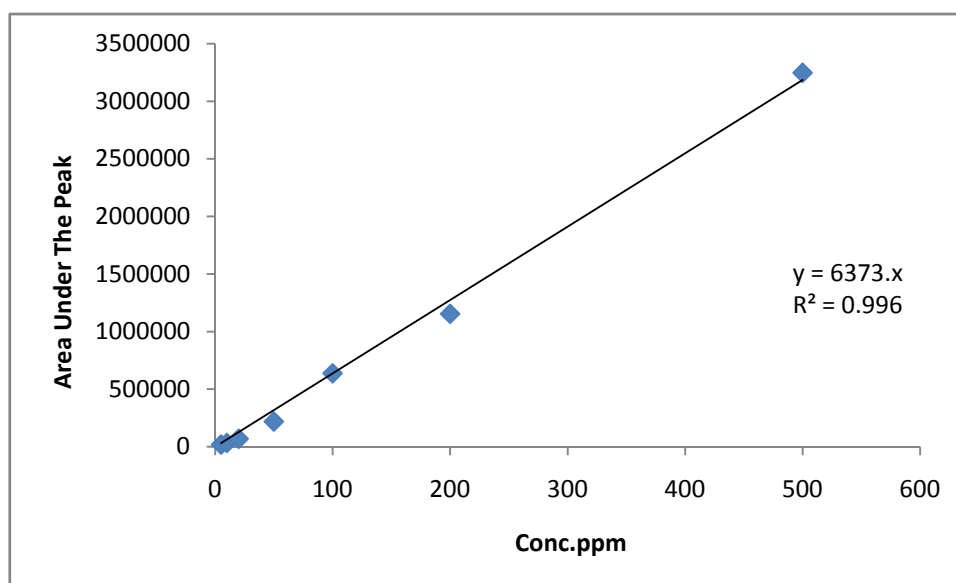

Figure 4.12: Calibration curve by using SPE for cefuroxime axetil.

#### 4.2.3 Efficiency of the wastewater treatment plant (WWTP) at Al-Quds University for the removal of Cefuroxime axetil

The efficiency of the wastewater treatment plant (WWTP) at Al-Quds University for cefuroxime axetil removal was studied. Result demonstrated that cefuroxime axetil was 70.90% removed at hollow fiber stage (UF-HF), while about 91.27% of cefuroxime axetil was removed at spiral wound (SW) stage, (Tables 4.9 and 4.10). At the activated carbon adsorbent point of the wastewater treatment plant, 96.03% of cefuroxime axetil was removed. The results also indicated that complete removal (100%) of cefuroxime axetil

was achieved after passing through the reverse osmosis membrane (RO) (Figures 4.13 and 4.14)

**Table 4.9: Removal of cefuroxime axetil through the hollow fiber (UF-HF), spiral wound (UF-SW), activated carbon adsorbent and reverse osmosis from the wastewater treatment plant at Al-Quds university.**

No.	Sample location name		Conc. of Cefuroxime axetil (ppm)	Conc. of Cefuroxime axetil (ppm)	Conc. of Cefuroxime axetil (ppm)
			First trial	Second trial	Third trial
1	Blank (before addition of cefuroxime axetil)		0	0	0
2	The initial concentration of cefuroxime axetil in storage tank (after addition of cefuroxime axetil)		19.5	19.1	19.5
3	HF-UF	Feed point	19.5	18.60	18
		Brine point	13.50	13.20	12.10
		Product point	5.66	5.73	5.89
4	HF-SW	Concentrated UF point	3.73	4.10	4.04
		Permeated UF point	1.89	1.34	1.85
5	Activated carbon point		0.88	0.63	0.80
6	Reverse osmosis (RO)	Permeated RO point	0.0	0.0	0.0

**Table 4.10: Accumulative % removal of cefuroxime axetil.**

Trial No.	Hollow fiber (HF)	Spiral wound (SW)	Activated carbon	Reverse osmosis (RO)
1	71.00%	90.30%	95.50%	100.00%
2	71.90%	93.00%	96.70%	100.00%
3	69.80%	90.50%	95.90%	100.00%
Average	70.90%	91.27%	96.03%	100.00%
SD	0.01	0.02	0.01	0.0

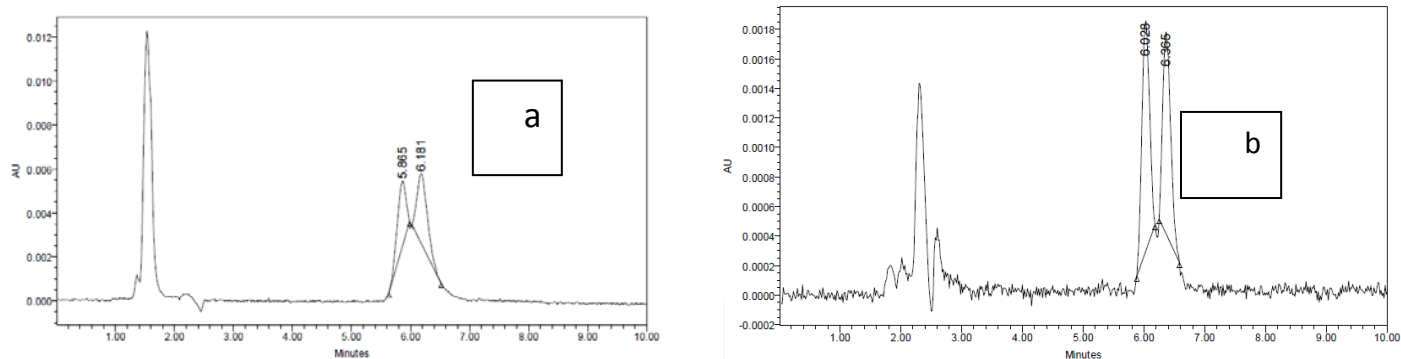

**Figure 4.13: Chromatograms showing the initial concentration of cefuroxime axetil (a), and after running the HF-UF point (b).**

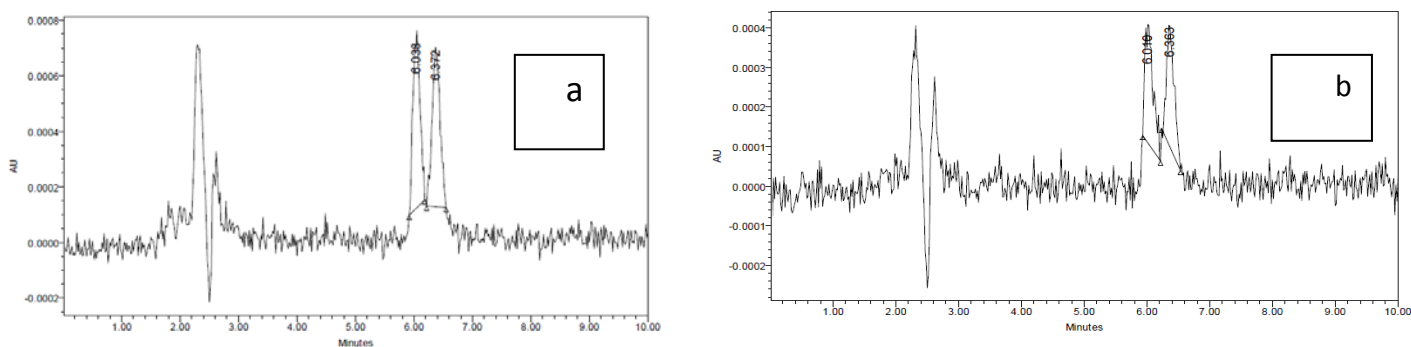

**Figure 4.14: Concentration of cefuroxime axetil before and after running the SW-UF point, (a&b), Respectively.**

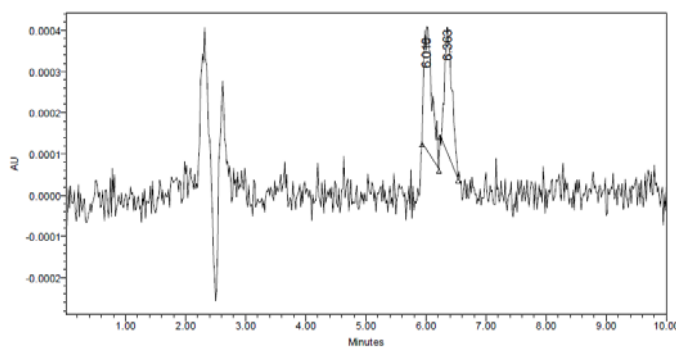

**Figure 4.15: Chromatogram showing the concentration of cefuroxime axetil after running activated charcoal adsorbent point .**

#### 4.2.4. Calibration curve for Cefuroxime axetil using uv-visible spectrophotometer

The calibration curve was obtained by plotting absorption versus concentration of cefuroxime axetil and is displayed in (Figure4.16) (8 data points). The Figure shows excellent linearity in the range 0.5-1000 ppm with correlation coefficient ( $R^2$ ) of 0.999, this indicates that the method used is linear.

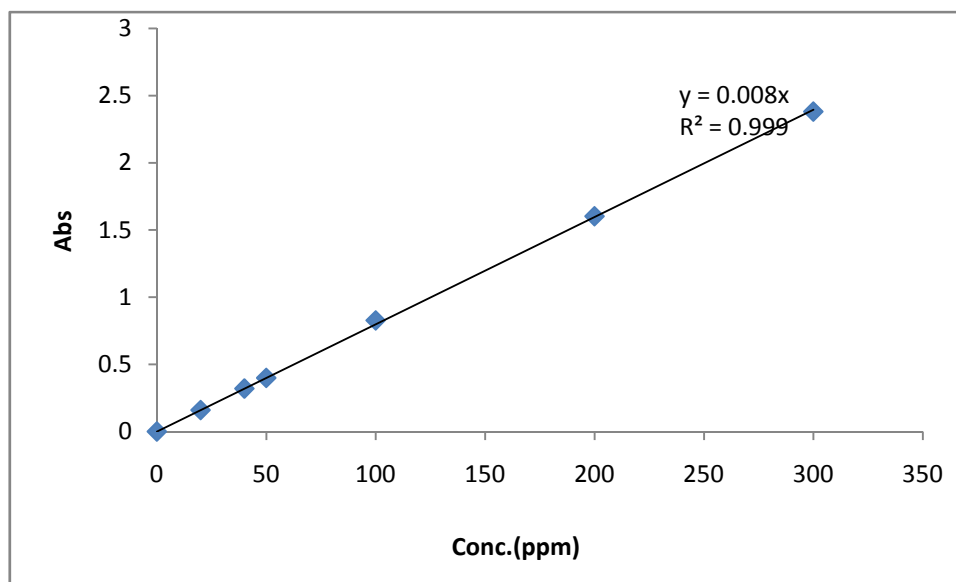

Figure 4.16 : calibration curve of cefuroxim axetil

#### 4.2.5 Adsorption studies of cefuroxim axetil on a micelle-clay complex (ODTMA) and activated charcoal

Adsorption mechanism depends on the physicochemical properties of the pharmaceutical and the aquifer media properties. Adsorption of cefuroxim axetil onto a micelle-clay complex and charcoal adsorbents was investigated and described in this section.

##### 4.2.5.1 Adsorption of cefuroxim axetil on a micelle-clay complex (ODTMA) and activated charcoal

Cefuroxim axetil removal by a micelle-clay complex and activated charcoal as studied. Samples were taken at different time intervals (0 -180 minutes). The results revealed that the micelle-clay complex is effective for the removal of cefuroxim axetil from spiked samples (100 ppm) at pH = 8.2. The removal was about 95.2% and was achieved after three hours.

The capacity of the micelle-clay complex and activated charcoal towards adsorption of cefuroxim axetil was quite comparable. The results showed that the adsorption of cefuroxim axetil on the micelle-clay complex is faster when compared to that on the activated charcoal (about 72.2% of cefuroxim axetil was removed in the first 5 minutes while only 49.5% of cefuroxim axetil was removed by the activated charcoal).

**Table 4.11: Percentage removal of cefuroxime axetil by micelle-clay complex (ODTMA) at pH 8.2**

Time(min)	Abs	Conc.( Ppm)	Mass(mg)	%removal
0	0.827	100	10	0
5	0.222	27.75	2.775	72.25
10	0.204	25.5	2.55	74.5
20	0.190	23.77	2.377	76.23
30	0.170	21.28	2.128	78.72
40	0.146	18.37	1.837	81.63
50	0.141	17.7	1.77	82.3
60	0.103	12.9	1.29	87.1
80	0.083	10.38	1.038	89.62
100	0.069	8.69	0.869	91.31
120	0.048	6.09	0.609	93.91
150	0.044	5.5	0.55	94.5
180	0.038	4.8	0.48	95.2

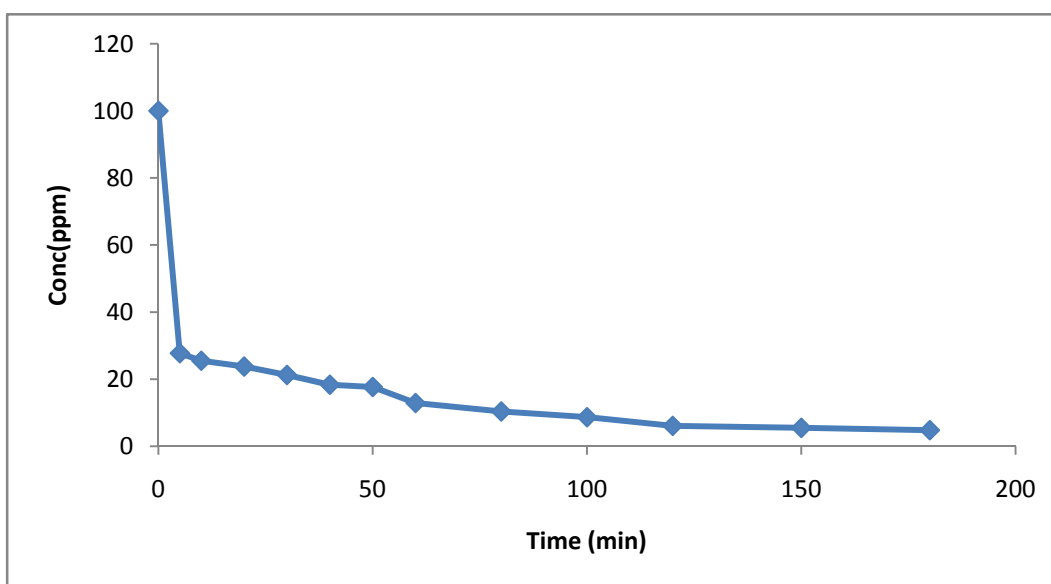
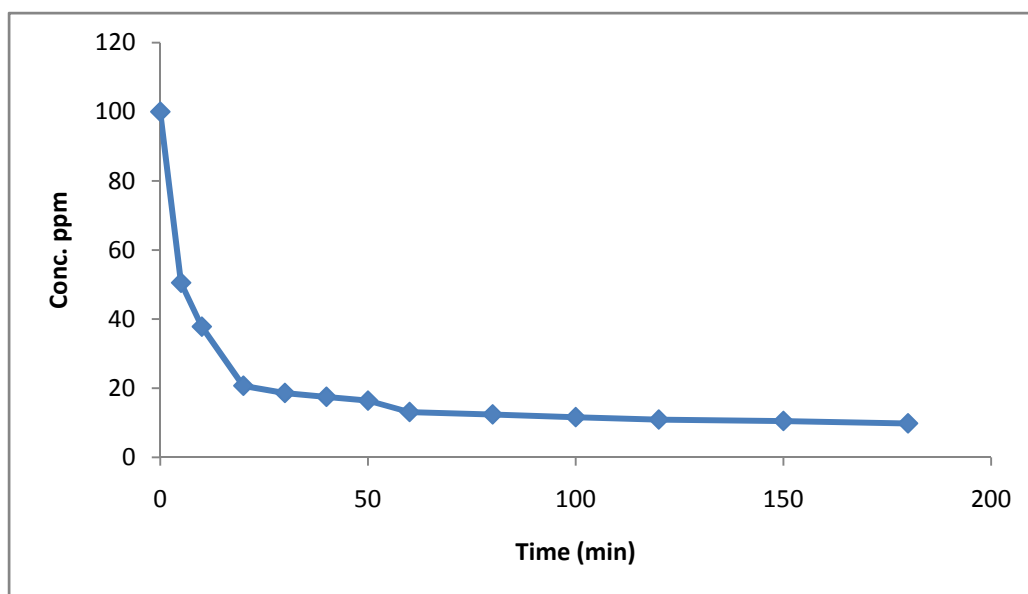

**Figure 4.17: Adsorption of cefuroxime axetil by micelle-clay complex (ODTMA) at pH 8.2**



**Table 4.12: Percentage removal of cefuroxime axetil by activated charcoal**

Time(min)	Abs	Conc. (ppm)	Mass(mg)	%Removal
0	0.827	100	10	0
5	0.404	50.5	5.05	49.5
10	0.302	37.8	3.78	62.2
20	0.165	20.7	2.07	79.3
30	0.148	18.6	1.86	81.4
40	0.140	17.5	1.75	82.5
50	0.132	16.4	1.64	83.6
60	0.104	13.1	1.31	86.9
80	0.099	12.4	1.24	87.6
100	0.092	11.6	1.16	88.4
120	0.087	10.9	1.09	89.1
150	0.084	10.5	1.05	89.5
180	0.078	9.80	0.98	90.2



**Figure 4.18: Adsorption of cefuroxime axetil by charcoal at pH 8.2**

#### 4.2.5.2 Analysis of adsorption isotherms

For this study the adsorption of cefuroxim axetil of five concentrations (20,50,100, 200, and 300 ppm) on the micelle-clay complex and activated charcoal were studied, then  $C_e$  and  $Q_e$  were calculated as in (Tables 4.13 and 4.14).  $C_e/Q_e$  vs.  $C_e$  was plotted for cefuroxim axetil adsorbed onto both micelle-clay complex and activated charcoal (Figure 4.19).

**Table 4.13: Concentrations in equilibrium obtained for adsorption test of cefuroxim axetil onto the adsorbent micelle-clay .( pH 8.2 and 25°C)**

Conc (ppm)	Mass(mg) Initial	Abs (T=180)	Conc (T=180)( $C_e$ )	Mass Final (mg)	M Initial- M Final	Q=(M Initial- M Final/0.5)	Ce/Qe
20	2	0.006	0.8	0.08	1.92	3.84	0.21
50	5	0.005	0.65	0.065	4.935	9.87	0.07
100	10	0.038	4.8	0.48	9.52	19.04	0.25
200	20	0.475	59.4	5.94	14.06	28.12	2.11
300	30	1.198	149.73	14.973	15.027	30.054	4.98

**Table 4.14: Concentrations in equilibrium obtained for adsorption test of cefuroxim axetil onto the adsorbent activated charcoal .( pH 8.2 and 25°C)**

Conc (ppm)	Mass (mg) Initial	Abs (T=180)	Conc (T=180)( $C_e$ )	Mass (mg) Final	M Initial- M Final	Q=(M Initial- M Final/0.5)	Ce/Qe
20	2	0.028	3.5	0.35	1.65	3.3	1.06
50	5	0.018	2.3	0.23	4.77	9.54	0.24
100	10	0.078	9.8	0.98	9.02	18.04	0.54
200	20	0.491	61.4	6.14	13.86	27.72	2.22
300	30	1.433	179.1	17.91	12.09	24.18	7.41

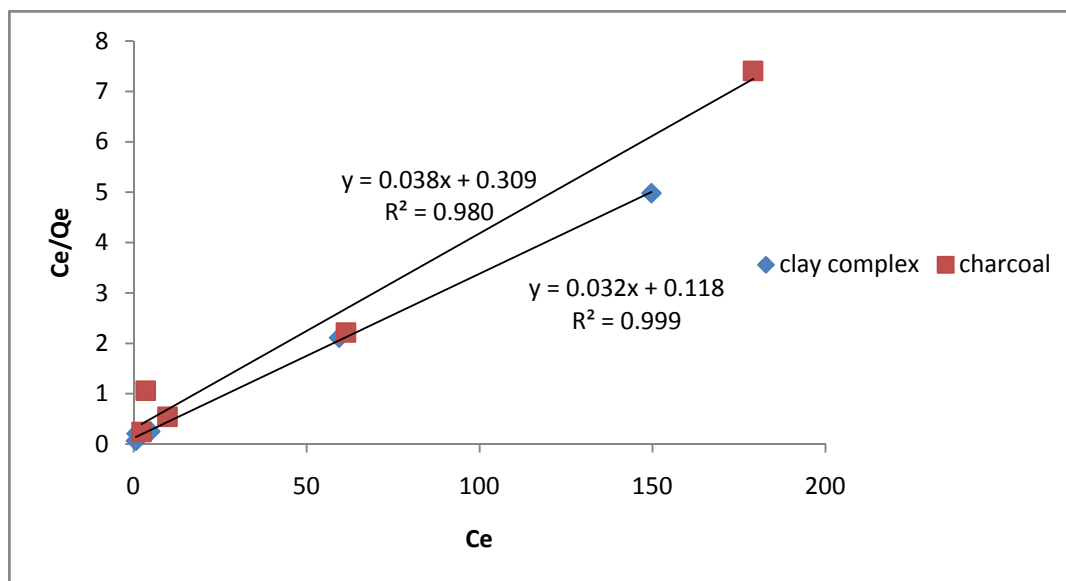

Figure. 4.19: Langmuir isotherms for the removal of cefuroxim axetil by activated charcoal (■) and by clay complex (◆). (pH 8.2, 25°C).

(Table 4.15) shows the values for  $Q_{\max}$  and  $k$  for cefuroxim axetil adsorbed on both micelle-clay complex and activated charcoal.

**Table 4.15: Langmuir adsorption parameters ( $k$  and  $Q_{\max}$ ) of cefuroxime axetil onto micelle-clay complex and activated charcoal adsorbents.**

Pharmaceutical	Adsorbents	Langmuir		
		K (L/mg)	$Q_{\max}$ (mg/g)	$R^2$
cefuroxim axetil	Micell- Clay complex	$0.271 \pm 0.003$	$31.25 \pm 0.65$	0.999
	Charcoal	$0.122 \pm 0.002$	$26.31 \pm 0.70$	0.980

\* Results of  $K$  and  $Q_{\max}$  are repeated as value  $\pm$  SD; SD: standard deviation of three replicates

The data fitted the Langmuir isotherm with  $R^2$  0.980 for activated charcoal and 0.999 for the micelle-clay complex (Figure 4.19). The Langmuir constants ( $k$  and  $Q_{\max}$ ) were calculated and are presented in Table 4.15. Inspection of Table 4.15 revealed that the adsorption isotherm with micelle-clay complex has larger  $Q_{\max}$  and  $K$  values than those that with activated carbon, thus rendering the former as better adsorbent for removal of cefuroxim axetil than the latter.

#### 4.2.6 Column Experiments

1000 mL of cefuroxim axetil (50ppm) were eluted in triplicate through column filters.

The results (Table 4.16) indicate a significant advantage of the micelle-clay filter in removing cefuroxim axetil compared to that removed by activated charcoal. This was not surprising, since the results for adsorption isotherm and in particular the kinetics have clearly shown that the micelle-clay-complex was more efficient than activated carbon in removing cefuroxim axetil from water.

**Table 4.16: Removal of cefuroxime axetil by filtration of its solution ( 50 ppm) through a laboratory filter, which included either a micelle-clay complex , or activated carbon mixed with excess sand at 1:25 (w/w).**

Volume Filtered (mL)	Concentration (ppm)	Column Type	Emerging concentration (ppm)	% Removal
1000	50	Micelle-clay	2.10±0.003	95.79
1000	50	Activated carbon	3.5±0.002	93

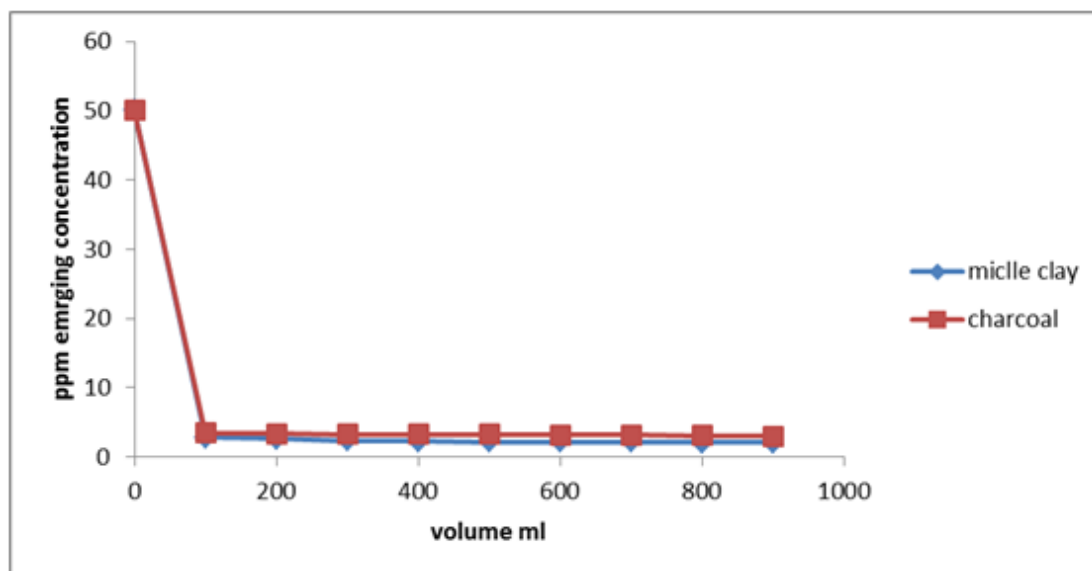

**Figure 4.20 Conc. Of cefuroxime Axetil Vs. Volume Of Samples Were Taken From micelle- Clay And Charcoals Column .**

## **Chapter Five**

# **Conclusions and Recommendations**

## Chapter Five:

---

### Conclusions and Recommendations:

#### 5.1 Conclusions

Advanced wastewater treatment plant utilizing ultra filtration, activated carbon and RO showed that (UF\_HF ) alone and (UF\_SW) are not efficient in removing amoxicillin trihydrate and cefuroxime axetil to safe level, but addition of activated carbon and RO enable their complete removal. Adsorption studies on micelle-clay complex (ODTMA) and charcoal revealed that both adsorbents are efficient for removal of amoxicillin trihydrate and cefuroxime axetil.

However, in filtration the differences will be larger.

The large effectiveness and removal capacity are due to a relatively high affinity of adsorption of the anionic amoxicillin trihydrate and cefuroxime axetil by the relatively large number of positively charged and hydrophobic sites of the micelle-clay complex based on ODTMA.

#### 5.2 Recommendations

The most important recommendations for supporting the efficiency of advanced membrane technology towards the removal of pharmaceuticals in Palestine are:

- Palestine, in particular, suffers from water shortage and poor water quality, hence wastewater treatment and reuse as a reliable source of fresh water is essential to be adopted by the Palestinians to meet future needs in a sustainable way.
- In Palestine wastewater treatment facilities must be improved to increase their capacity, provide good maintenance, and have a trained staff.
- Associate projects for municipalities are needed to provide wastewater treatment plants especially in industrial, agricultural, and hospital areas using advanced membrane technologies instead of traditional wastewater treatment pools. This is because it is efficient in terms of the removal of traces of pharmaceuticals.

- Educating the general public in the Palestinian society on how the pharmaceuticals should be disposed in order to prevent their entry into the environment. This can be done by raising the awareness towards the household disposal of unused and expired pharmaceuticals.

## References

- [1] Nazer, D. W., Siebel, M. A., Van der Zaag, P., Mimi, Z., & Gijzen, H. J. (2008). Water Footprint of the Palestinians in the West Bank<sup>1</sup>. *JAWRA Journal of the American Water Resources Association*, 44(2), 449-458.
- [2] McNeill, L. S., Almasri, M. N., & Mized, N. (2009). A sustainable approach for reusing treated wastewater in agricultural irrigation in the West Bank–Palestine. *Desalination*, 248(1), 315-321.
- [3] Lonergan, S. C., & Brooks, D. B. (1994). *Watershed: the role of fresh water in the Israeli-Palestinian conflict*. International Development Research Centre, Ottawa .
- [4] Birzeit University, (2005). *Prospects of efficient wastewater management and water reuse in Palestine*. EMWATER-Project Efficient Management of Wastewater, its Treatment and Reuse in the Mediterranean Countries Institute for Water Studies, Birzeit, West Bank, Palestine.
- [5] Bdour, A. N., Hamdi, M. R., & Tarawneh, Z. (2009). Perspectives on sustainable wastewater treatment technologies and reuse options in the urban areas of the Mediterranean region. *Desalination*, 237(1), 162-174.
- [6] German-Israeli-Palestinian project submitted to Friends of Environment and Water (FEW) and House of Water and Environment (HWE) (2006). *Collective water study. Experiences with Use of Treated Wastewater for Irrigation in Palestine*.
- [7] *Social justice through human rights (2001), The right to water in Palestine :*  
a back ground .
- [8] Zahra, A., & Ahmad, B. A. (2001). Water crisis in Palestine. *Desalination*, 136(1), 93-99.
- [9] Khamis, M., Karaman, R., Qurie, M., Abbadi, J., Nusseibeh, S., Manassra, A., & Nir, S. (2012). Performance of micelle-clay filters for removing pollutants and bacteria from tertiary treated wastewater. *Journal of Environmental Science and Engineering A*, 1(2), 160-168.



- [10] Al-Tamimi A, Rabi A, Abu-Rahma A, (2008). The Palestinian Hydrology Groups Experience in Grey Water Treatment and Reuse in the Palestinian Rural Areas. Proceedings of the first Symposium on wastewater reclamation and reuse for water management in Palestine.
- [11] Abu-Madi M, Al-Sa□ed R, Braadbart O, and Alaerts G, (2000), Selection criteria for appropriate sanitation in the Palestinian rural and semi-urban communities, Proceedings of the International Symposium on Water Sector Capacity Building and Research in Palestine, Birzeit University, Palestine.
- [12] Bdour, A. N., Hamdi, M. R., & Tarawneh, Z. (2009). Perspectives on sustainable wastewater treatment technologies and reuse options in the urban areas of the Mediterranean region. *Desalination*, 237(1), 162-174.
- [13] Metcalf, L., Eddy, H. P., & Tchobanoglous, G. (2003). *Wastewater engineering. Treatment, disposal, and reuse*. 4th ed., McGraw-Hill. New York.
- [14] Egun, N. K. (2010). Effect of channelling wastewater into water bodies: A case study of the Orogo River in Agbor, Delta State. *Journal of Human Ecology*,31(1), 47-52.
- [15] Agriculture And Natural Resources water quality:Managing Wastewater. Municipal Wastewater Treatmentm.Wastewater Collection And Treatment Processes. A L A B A M A A & M A N D A U B U R N U N I V E R S I T I E S.
- [16] Scott, C. A., Faruqui, N. I., & Raschid-Sally, L. (Eds.). (2004). *Wastewater use in irrigated agriculture: Confronting the livelihood and environmental realities*. CABI.
- [17] Ottosson, J. (2003). *Hygiene Aspects of Greywater and Greywater Reuse*, Royal Institute of Technology (KTH) Department of Land and Water Resources Engineering.
- [18] City of Guelph, Environmental Services Department, Wastewater Services Division. *Introduction to wastewater treatment*.
- [19] Environmental Protection Agency (EPA) (1997).*Wastewater Treatment Manuals: Primary, Secondary and Tertiary treatment*. (EPA, Ireland). Available onlineat: [http://www.epa.ie/downloads/advice/water/wastewater/EPA\\_water\\_%20treatment\\_manual\\_primary\\_secondary\\_tertiary1.pdf](http://www.epa.ie/downloads/advice/water/wastewater/EPA_water_%20treatment_manual_primary_secondary_tertiary1.pdf) / Accessed: October,2010.

- [20] World Health Organization (WHO) (2006). Guidelines for the Safe Use of Wastewater, Excreta and Greywater: Wastewater Use in Agriculture. 3rd ed., Vol. (1), Geneva . Available online at: [http://whqlibdoc.who.int/publications/2006/9241546824\\_eng.pdf/](http://whqlibdoc.who.int/publications/2006/9241546824_eng.pdf/) Accessed: October,2010.
- [21] Al-Momani, F. (2003). Combination of photo-oxidation processes with biological treatment. Universitat de Barcelona.
- [22] United States Environmental Protection Agency (US.EPA) (2004). Primer for Municipal Wastewater treatment systems. U.S.EPA, Washington.
- [23] Bielefeldt, A. (2009). Water treatment, Industrial. Applied Microbiology Journal. 569-586.
- [24] Okoh, A. I., Odjadjare, E. E., Igbinsosa, E. O., & Osode, A. N. (2007). Wastewater treatment plants as a source of microbial pathogens in receiving watersheds. African Journal of Biotechnology, 6(25), 2932-2944.
- [25] Benítez, F. J., Acero, J. L., Leal, A. I., & Real, F. J. (2008). Ozone and membrane filtration based strategies for the treatment of cork processing wastewaters. Journal of hazardous materials, 152(1), 373-380.
- [26] Acero, J. L., Benitez, F. J., Leal, A. I., Real, F. J., & Teva, F. (2010). Membrane filtration technologies applied to municipal secondary effluents for potential reuse. Journal of hazardous materials, 177(1), 390-398.
- [27] Mallevalle J, Odendaal P, and Wiesner M, (1996). Water Treatment Membrane Processes. New York: McGraw-Hill.
- [28] Chang, I. S., & Kim, S. N. (2005). Wastewater treatment using membrane filtration—effect of biosolids concentration on cake resistance. Process Biochemistry, 40(3), 1307-1314.
- [29] Tansel, B. (2008). New technologies for water and wastewater treatment: a survey of recent patents. Recent Patents on Chemical Engineering, 1(1), 17-26.

[30] Chollangi, A. (2009). Comparison of two ultrafiltration membrane systems for whole milk feta cheese production: a thesis presented in partial fulfilment of the requirements for the degree of Master of Technology in Food Technology at Massey University, Auckland, New Zealand (2, 4, 7, 8).

[31] Alyson Sagle and Benny Freeman, Fundamentals of Membranes for Water Treatment, University of Texas at Austin.

[32] Tansel, B. (2008). New technologies for water and wastewater treatment: a survey of recent patents. Recent Patents on Chemical Engineering, 1(1), 17-26.

[33] United States Environmental Protection Agency (US.EPA) (2005). Membrane Filtration Guidance Manual. Office of water, EPA/815/R-06/009. Available online at: [http://www.epa.gov/ogwdw/disinfection/lt2/pdfs/guide\\_lt2\\_membranefiltration\\_final.pdf/](http://www.epa.gov/ogwdw/disinfection/lt2/pdfs/guide_lt2_membranefiltration_final.pdf/) Accessed: October ,2010.

[34] Kok Keong L. (2007). Feed Spacer Of Spiral Wound Membrane Module For Nanofiltration And Reverse Osmosis: Modeling ,Simulation And Design.

[35] United States Environmental Protection Agency (US.EPA) (1996). Capsule Report: Reverse Osmosis Process. Office of research and development, EPA/625/R-96/009.82 Available online at: <http://www.epa.gov/nrmrl/pubs/625r96009/625r96009.pdf/> Accessed: October, 2010.

[36] Wintgens, T., Melin, T., Schäfer, A., Khan, S., Muston, M., Bixio, D., & Thoeye, C. (2005). The role of membrane processes in municipal wastewater reclamation and reuse. Desalination, 178(1), 1-11.

[37] Gros, M., Petrović, M., & Barceló, D. (2006). Multi-residue analytical methods using LC-tandem MS for the determination of pharmaceuticals in environmental and wastewater samples: a review. Analytical and bioanalytical chemistry, 386(4), 941-952.

[38] Khamis, M., Karaman, R., Ayyash, F., Qtait, A., Deeb, O., & Manassra, A. (2011). Efficiency of advanced membrane wastewater treatment plant towards removal of aspirin, salicylic acid, paracetamol and p-aminophenol. J. Environ. Sci. Eng, 5(2), 121-137.

[39] Tyler, C.R., Routledge E.J. (1998). Natural and anthropogenic environmental estrogens: the scientific basis for risk assessment. Estrogenic effects in fish in English rivers with evidence of their causation. *Pure Appl. Chem*, 70, 1795–804.

[40] Johnson, A. C., Belfroid, A., & Di Corcia, A. (2000). Estimating steroid oestrogen inputs into activated sludge treatment works and observations on their removal from the effluent. *Science of the Total Environment*, 256(2), 163-173.

[41] Johnson, A. C., & Sumpter, J. P. (2001). Removal of endocrine-disrupting chemicals in activated sludge treatment works. *Environmental Science & Technology*, 35(24), 4697-4703.

[42] Ternes, T. A. (1998). Occurrence of drugs in German sewage treatment plants and rivers. *Water research*, 32(11), 3245-3260.

[43] H. Jones, O. A., Voulvoulis, N., & Lester, J. N. (2005). Human pharmaceuticals in wastewater treatment processes. *Critical Reviews in Environmental Science and Technology*, 35(4), 401-427.

[44] Hirsch, R., Ternes, T.A., Haberer, K., Kratz, K.L. (1996). Determination of beta blockers and b-sympathomimetics in the aquatic environment. *Vom. Wasser*, 87, 263–74.

[45] Bendz, D., Paxéus, N. A., Ginn, T. R., & Loge, F. J. (2005). Occurrence and fate of pharmaceutically active compounds in the environment, a case study: Høje River in Sweden. *Journal of Hazardous Materials*, 122(3), 195-204.

[46] Comerton, A. M., Andrews, R. C., & Bagley, D. M. (2009). Practical overview of analytical methods for endocrine-disrupting compounds, pharmaceuticals and personal care products in water and wastewater. *Philosophical Transactions of the Royal Society A: Mathematical, Physical and Engineering Sciences*, 367(1904), 3923-3939.

[47] Ternes, T. A., Hirsch, R., Mueller, J., & Haberer, K. (1998). Methods for the determination of neutral drugs as well as betablockers and  $\beta$ 2-sympathomimetics in

aqueous matrices using GC/MS and LC/MS/MS. *Fresenius' journal of analytical chemistry*, 362(3), 329-340.

[48] Kosjek, T., Heath, E., & Krbavčič, A. (2005). Determination of non-steroidal anti-inflammatory drug (NSAIDs) residues in water samples. *Environment international*, 31(5), 679-685.

[49] Larsen, T. A., Lienert, J., Joss, A., & Siegrist, H. (2004). How to avoid pharmaceuticals in the aquatic environment. *Journal of Biotechnology*, 113(1), 295-304.

[50] Gros, M., Petrovic, M., & Barceló, D. (2008). Analysis of Emerging Contaminants of Municipal and Industrial Origin. In *Emerging Contaminants from Industrial and Municipal Waste* (pp. 37-104). Springer Berlin Heidelberg.

[51] Launay, F. M., Young, P. B., Sterk, S. S., Blokland, M. H., & Kennedy, D. G. (2004). Confirmatory assay for zeranol, taleranol and the *Fusarium* spp. toxins in bovine urine using liquid chromatography-tandem mass spectrometry. *Food additives and contaminants*, 21(1), 52-62.

[52] Chopra, I., & Roberts, M. (2001). Tetracycline antibiotics: mode of action, applications, molecular biology, and epidemiology of bacterial resistance. *Microbiology and Molecular Biology Reviews*, 65(2), 232-260.

[53] Yang, S., & Carlson, K. (2003). Evolution of antibiotic occurrence in a river through pristine, urban and agricultural landscapes. *Water Research*, 37(19), 4645-4656.

[54] Fent, K., Weston, A. A., & Caminada, D. (2006). Ecotoxicology of human pharmaceuticals. *Aquatic toxicology*, 76(2), 122-159.

[55] Li, S. Z., Li, X. Y., & Wang, D. Z. (2004). Membrane (RO-UF) filtration for antibiotic wastewater treatment and recovery of antibiotics. *Separation and Purification Technology*, 34(1), 109-114.

[56] Kolpin, D. W., Furlong, E. T., Meyer, M. T., Thurman, E. M., Zaugg, S. D., Barber, L. B., & Buxton, H. T. (2002). Pharmaceuticals, hormones, and other organic wastewater

contaminants in US streams, 1999-2000: A national reconnaissance. *Environmental science & technology*, 36(6), 1202-1211.

[57] Weigel, S. (2003). Occurrence, distribution and fate of pharmaceuticals and further polar contaminants in the marine environment. Institute of Organic Chemistry University of Hamburg, Hamburg

[58] Nghiem, L. D., Schäfer, A. I., & Elimelech, M. (2005). Pharmaceutical retention mechanisms by nanofiltration membranes. *Environmental science & technology*, 39(19), 7698-7705.

[59] Reif, R., Suárez, S., Omil, F., Lema, J., (2008). Fate of pharmaceuticals and cosmetic ingredients during the operation of a MBR treating sewage. *Desalination*, 221(1), 511-517.

[60] Wiegand, S., Aulinger, A., Brockmeyer, R., Harms, H., Löffler, J., Reincke, H., Schmidt, R., Stachel, B., Von T.W., Wanke, A. (2004). Pharmaceuticals in the river Elbe and its tributaries. *Chemosphere*, 57 (2), 107–126.

[61] Hari, A. C., Paruchuri, R. A., Sabatini, D. A., & Kibbey, T. C. (2005). Effects of pH and cationic and nonionic surfactants on the adsorption of pharmaceuticals to a natural aquifer material. *Environmental science & technology*, 39(8), 2592-2598.

[62] Huang, C., Renew, J., Smeby, K., Pinkston, K., Sedlak, D. (2001). Assessment of potential antibiotic contaminants in water and preliminary occurrence analysis. *Water Resource. Update*, 120 (1), 30–40.

[63] Jiao, S., Zheng, S., Yin, D., Wang, L., Chen, L. (2008). Aqueous photolysis of tetracycline and toxicity of photolytic products to luminescent bacteria. *Chemosphere*, 73, 377–382.

[64] Zhang, J. Q., & Dong, Y. H. (2008). Effect of low-molecular-weight organic acids on the adsorption of norfloxacin in typical variable charge soils of China. *Journal of hazardous materials*, 151(2), 833-839.

[65] Figueroa, R. A., Leonard, A., & MacKay, A. A. (2004). Modeling tetracycline antibiotic sorption to clays. *Environmental science & technology*, 38(2), 476-483.

[66] Radjenovic, J., Petrovic, M., & Barceló, D. (2007). Analysis of pharmaceuticals in wastewater and removal using a membrane bioreactor. *Analytical and Bioanalytical Chemistry*, 387(4), 1365-1377.

[67] Karaman, R., Khamis, M., Quried, M., Halabieh, R., Makharzeh, I., Manassra, A., & Nir, S. (2012). Removal of diclofenac potassium from wastewater using clay-micelle complex. *Environmental technology*, 33(11), 1279-1287.

[68] Polubesova, T., Zadaka, D., Groisman, L., & Nir, S. (2006). Water remediation by micelle-clay system: case study for tetracycline and sulfonamide antibiotics. *Water research*, 40(12), 2369-2374. from Professor Nir at The Hebrew University .

[69] Al-Abachi, M. Q., Haddi, H., & Al-Abachi, A. M. (2005). Spectrophotometric determination of amoxicillin by reaction with *N,N* dimethyl-*p*-phenylenediamine and potassium hexacyanoferrate(III). *Journal of analytical chemical acta*, 554(1), 184-189.

[70] British Pharmacopoeia 2009.

[71] Hernando, M. D., Mezcua, M., Fernández-Alba, A. R., & Barceló, D. (2006). Environmental risk assessment of pharmaceutical residues in wastewater effluents, surface waters and sediments. *Talanta*, 69(2), 334-342.

[72] Jones, H. O. A., Voulvoulis, N., & Lester, J. N. (2005). Human pharmaceuticals in wastewater treatment processes. *Critical Reviews in Environmental Science and Technology*, 35(4), 401-427.

[73] Gavrilescu, M. (2010). Environmental biotechnology: achievements, opportunities and challenges. *Dynamic Biochemistry, Process Biotechnology and Molecular Biology*, 4(1), 1-36.

[74] Jelińska, A., Dudzińska, I., Zajac, M., Oszczapowicz, I., & Krzewski, W. (2004). The stability of Cefuroxime axetil in tablets. *Acta poloniae pharmaceutica*, 62(3), 183-187.

[75] Mishael, Y. G., Undabeytia, T., Rytwo, G., Papahadjopoulos-Sternberg, B., Rubin, B., & Nir, S. (2002). Sulfometuron incorporation in cationic micelles adsorbed on montmorillonite. *Journal of agricultural and food chemistry*, 50(10), 2856-2863.

- [76] Adams, C., Wang, Y., Loftin, K., & Meyer, M. (2002). Removal of antibiotics from surface and distilled water in conventional water treatment processes. *Journal of Environmental Engineering*, 128(3), 253-260.
- [77] Mishaël, Y. G., Undabeytia, T., Rytwo, G., Papahadjopoulos-Sternberg, B., Rubin, B., & Nir, S. (2002). Sulfometuron incorporation in cationic micelles adsorbed on montmorillonite. *Journal of agricultural and food chemistry*, 50(10), 2856-2863
- [78] Polubesova, T., Nir, S., Zadaka, D., Rabinovitz, O., Serban, C., Groisman, L., & Rubin, B. (2005). Water purification from organic pollutants by optimized micelle-clay systems. *Environmental science & technology*, 39(7), 2343-2348.
- [79] Zadaka, D., Mishaël, Y. G., Polubesova, T., Serban, C., & Nir, S. (2007). Modified silicates and porous glass as adsorbents for removal of organic pollutants from water and comparison with activated carbons. *Applied Clay Science*, 36(1), 174-181.
- [80] Dakiky, M., Khamis, M., Manassra, A., & Mer'eb, M. (2002). Selective adsorption of chromium (VI) in industrial wastewater using low-cost abundantly available adsorbents. *Advances in environmental research*, 6(4), 533-540.



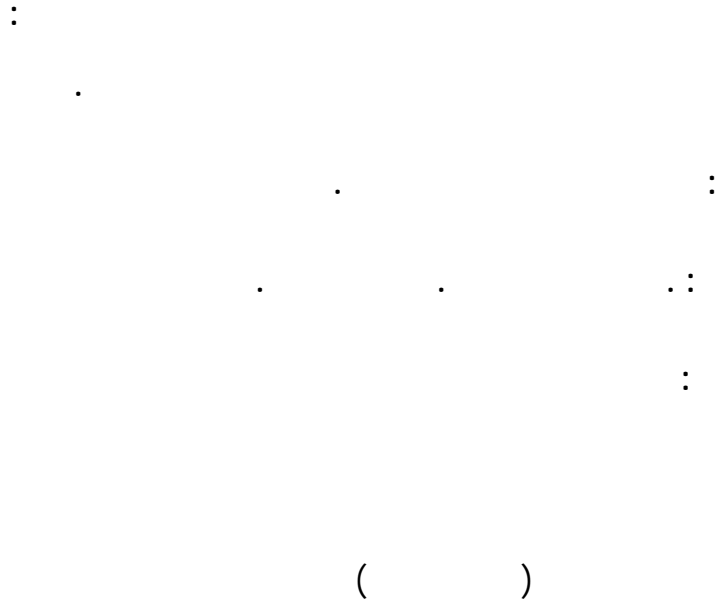

%96.4 (activated carbon adsorbent)

(Activated carbon

adsorbent)

(Batch)

(Clay-micellecomplex)

25

(Adsorption isotherm)

(Langmuir isotherm)

/ 90.91 / 100(Qmax)

/ 31.25 / 26.31

(column filter)