

Deanishp of Graduate Studies
Al-Quds University

Measurement of Soil Bulk Density by Using Gamma Ray
Backscattering Spectroscopy

Ala' Mahmoud Abed- El-Muneem Thawabteh

M.Sc. Thesis

Jarusalem-Palestine

1429/2008

Measurement of Soil Bulk Density by Using Gamma Ray
Backscattering Spectroscopy

Prepared By:

Ala' Mahmoud Abed-El-Muneem Thawabteh

B.Sc. Medical Imaging, College of Health Professions-
Palestine

Supervisor: Dr. Adnan Lahham

A thesis Submitted in Partial Fulfillment of Requirements
of the degree of Master of Science in
Environmental Studies

Department of Earth and Environmental Sciences
Faculty of Science and Technology- Al-Quds University

1429/2008

Al-Quds University
Deanship of Graduate Studies
Environmental Studies
Department of Earth and Environmental Science

Thesis approval

Measurement of Soil Bulk Density by Using Gamma Ray Backscattering
Spectroscopy

Prepared By: Ala' M. A. Thawabteh

Registration No. 20411726

Supervisor: Dr. Adnan Lahham

Master thesis submitted and accepted: / /

The names and signatures of examining Committee members are as follows:

1. Head of Committee: Dr. Adnan Lahham Signature.....
2. Internal Examiner: Dr. Adnan Joudeh Signature.....
3. External Examiner: Dr. Musa Abu-Teir Signature.....

Jerusalem- Palestine

1429 / 2008

Dedication

To

My Beloved Father Mahmoud Thawabteh, My Beloved Mother Nawal Thawabteh,
My Beloved Brothers Anas, Amein and Mohammad, My beloved sister Ayah, My Beloved
Fiancé Amein, Teachers from was being in the first grade until now and My Beloved Friends.

Declaration:

I Certify that this thesis submitted for the degree of Master is the result of my own research, except where otherwise acknowledged, and that this thesis (or any part of it) has not been submitted for a higher degree to any other university or institution.

Signed.....

Ala' Mahmoud Abed-El-Muneem Thawabteh

Date: / /

Acknowledgements

First of all, great thanks to the Almighty Allah, the Creator of the Universe. Many thanks are extended to my supervisor Dr. Adnan Lahham for his continuous and generous advising and guidance through the whole research. Furthermore, much appreciation is given to my teacher Mr. Mustafa Awiees for his support to continue my higher education and for my colleague Mr.Hussein Al-Masri.

Abstract

This study deals with a nuclear method of Gamma- Ray Backscattering Spectroscopy as a method that could be applied in measuring material bulk density specially soil density.

The detection system consists of a 3'' × 3'' inch NaI(Tl) detector connected to multichannel analyzer Inspector 2000 from Canberra instruments and lap top computer. ¹³⁷Cs is used as a Gamma-Ray emitter with energy of 662 KeV. Different soil types with different bulk densities are used in calibration process.

Before applying this technology in the field, calibration process took place in order to find a relationship between material bulk density and the collected count rate for that material. Calibration measurements are performed using three different material with three different bulk densities filled in wooden boxes constructed specially for this purpose with dimensions of 59×42×34 cm. Gamma ray source is shielded to prevent direct gamma photons from reach the detector in direct way. The detector and shielded gamma-ray source are placed on the top of the material's surface, and gamma ray spectrum for ¹³⁷Cs is collected for measurement times of 60 seconds to prevent background radiation measurement and the elevation on instrument's temperature which could lead to mistaken the measurement.

Collected spectra are analyzed using Genie 2000 software. Count rates are calculated for each spectrum, then a calibration curve is found making it easy to find the mathematical relationship between the count rate and the bulk density. Field measurements of bulk density (BD) are performed to check the validity of the system calibration. Results of Terra Rossa soil were in very good agreement with the measurement density.

Count Rate for the calibration process for Terra Rossa with 10 cm as a detector-source separation distance was (406 counts. s⁻¹), in the Terra Rossa field with the same distance (430 counts.s⁻¹). With using 20 cm, count rate in calibration process was (144 counts.s⁻¹), in the field it was (141 counts.s⁻¹), we can notice how much the measurements are closed., the count rate from energy range of (250-730 KeV). Measurement of bulk density are conducted in five different locations at Al-Quds University Main-Campus site. Results of there measurements are consistent relating to the type of soil and other materials present at the investigated locations.

Field measurements also are performed to study the effect of rain on soil bulk density determination.

قياس الكثافة الظاهرية للتربة باستخدام مطيافية أشعة جاما

ملخص

تناقش هذه الدراسة طريقة لقياس كثافة المواد الظاهرية بواسطة استخدام تقنية نووية. و لتحقيق هذا استخدمت تقنية مطيافية أشعة جاما الحقلية.

يتكون نظام القياس من مكشاف اشعاع و ميسي (بلورة يوديد الصوديوم المطعم بعنصر الثاليوم) بحجم 3×3 انش متصل مع محلل طيف من نوع Inspector 2000 من شركة كانبيرا و ذلك مع جهاز كمبيوتر محمول. استخدم عنصر ^{137}Cs بطاقة (662 KeV) كمصدر لأشعة جاما ، كما استخدمت أنواع مختلفة من التربة بكثافات ظاهرية مختلفة لاجراء عملية المعايرة.

قبل تطبيق هذه التقنية في الحقل أجريت عملية المعايرة لايجاد علاقة مناسبة بين كثافة المادة الظاهرية و طيف جاما الذي تم جمعه (قياسه). تمت عملية المعايرة باستخدام ثلاثة مواد مختلفة ذات ثلاثة كثافات مختلفة معبأة بداخل صناديق خشبية بأبعاد $59 \times 42 \times 34$ سم صنعت مخصصة لهذا الغرض. يغطي مصدر اشعاع جاما (^{137}Cs) بدرع من الرصاص لمنع مرور أشعة جاما بشكل مباشر نحو المكشاف . ثم يوضع كل من مصدر أشعاع جاما و المكشاف فوق سطح المادة المراد قياسها لتبدأ عملية القياس لوقت قصير(60)ثانية. حتى يتم تفادي قياس شعاع جاما الطبيعي في بيئة القياس و تفادي ارتفاع درجة حرارة الاجهزة الذي يؤدي الى احداث فروقات في القراءات.

تعالج أطياف جاما التي تم جمعها و قياسها باستخدام نظام Genie 2000 . يحسب معدل اشعاع جاما (Count Rate) لكل عملية قياس على حده. ثم يوضع منحنى المعايرة الذي يوضح العلاقة بين كثافة المادة و معدل اشعاع جاما الذي تمت معالجته مما يسهل ايجاد علاقة رياضية مناسبة بين كثافة المادة و معدل اشعاع جاما.

تمت عملية القياس في الحقل حتى يتم التأكد من مدى دقة عملية المعايرة. النتائج الخاصة بتربة Terra Rossa كانت متوافقة جدا مع النتائج التي تم قياسها من قبل.

تم القيام بقياسات الحقل بعد انتهاء عملية المعايرة مستخدمين العلاقة الناتجة عن عملية المعايرة، حيث كان معدل العد في عملية المعايرة Terra Rossa وباستخدام مسافة 10 سم و هي المسافة الفاصلة بين المكشاف و مصدر اشعاع جاما ($406 \text{ counts.s}^{-1}$) ، و كان القياس في الحقل و على نفس المسافة ($430 \text{ counts.s}^{-1}$) ، اما باستخدام مسافة 20 سم كان القياس في عملية المعايرة ($144 \text{ counts.s}^{-1}$) اما في الحق ($141 \text{ counts.s}^{-1}$)، و نلاحظ تقارب النتائج، و هذا في مجال الطاقة الذي يمثل الجزء (KeV 730 - 250) من طيف أشعة جاما. و قد أجريت قياسات ميدانية في خمسة مواقع مختلفة في الحرم الرئيسي في جامعة القدس. و تشير نتائج تقدير الكثافة الظاهرية في المناطق الخمسة المختلفة الى نتائج منطقية تتناسب و نوعية التربة و المواد المتواجدة في مواقع القياس.

كما ان عملية القياس قد اجريت ايضا بهدف قياس تأثير مياه الامطار على قياس كثافة التربة.

Table of Contents

	Page
Declaration	i
Acknowledgements	ii
English Abstract	iii
Arabic Abstract	v
Table of Contents	vii
List of Tables	xi
List of Figures	xii
Definitions and Abbreviations	xvii
Chapter I : Soil Bulk Density	1
1.1 Introduction	1
1.2 Importance of soil bulk density determination in soil science	6
1.3 Environmental factors that affect soil bulk density	7
1.4 Soil Bulk Density Determination	10
1.4.1 Sampling Methods	10
a. Core Method	11
b. Clod Method	12
c. Excavation Method	13

Chapter II: Radiation Methods for Soil Bulk Density Determination 16

2.1 Types of Radiation Methods for measuring soil bulk density	16
2.1.1 Transmission method	17
2.1.1.1 Theory of radiation transmission method	19
2.1.2 Backscattering Method	21

Chapter III : Backscattering Gamma Ray Spectroscopy

3.1 Gamma Ray	24
3.2 Interaction of Gamma Ray With Matter	25
3.2.1 Photoelectric Absorption	26
3.2.2 Compton Scattering	27
3.2.3 Pair production	29
3.3 Gamma Ray Spectrum	30
3.4 Gamma ray backscattering spectroscopy theory	35
3.5 Basic principles of Gamma – Ray Backscattering Spectroscopy	36
3.5.1 Parameters affecting detected count rate for a backscatter densitometer	38

Chapter IV: Methodology and Instrumentation	39
4.1 Instrumentation	39
4.1.1 Electronics	39
4.1.2 Detector	40
4.1.3 Multi channel analyzer (PMT)	41
4.2 Genie 2000 Basic Spectroscopy Software	41
4.3 Calibration materials of the detecting system	42
4.3.2 Calibration boxes	44
4.3.3 Gamma-ray source	45
4.4 Gamma ray backscattering spectroscopy calibration	45
4.4.1 Field calibration	46
4.4.2 Methodology of field calibration	47
4.5 Field measurement methodology	50
Chapter V: Results and discussion	53
5.1 Optimization of Detector – Source separation distance	54
5.1.1 Gamma Ray spectra collected for Terra Rossa	54
5.1.2 Gamma Ray spectra collected for lime stone (powder)	60
5.1.3 Gamma Ray spectra collected for sand	61
5.2 Effect of various soils density on Gamma_Ray spectra	62
5.2.1 Gamma Ray Count rate in the range of 250 -731 KeV	62
5.2.2 Gamma Ray Count rate from the Compton backscattering peck within energy range of 180 – 480 KeV	65
5.3 Establishing the relationship between soil bulk density and detector response	67

5.3.1 Relationship of the measured density Vs gamma ray count rate with 10 cm detector-source separation distance	68
5.3.2 Relationship of the measured density Vs gamma ray count rate with 20 cm detector-source separation distance	70
5.4 Field measurements	72
5.4.1 Using the equations to calculate the Terra Rossa soil field bulk density	74
5.4.2 Measurements of soil density at Al-Quds University site	75
5.6 Rain effect on soil bulk density	77
5.7 Conclusion and Recommendation	81
References	83
Arabic Abstract	87

List of Tables

		Page
Table 4.1	Materials with known densities used for calibration of the nuclear detection system.	46
Table 5.1	Gamma Ray count Rate for all calibration material in variant detector-source separation distances in gamma energy range (250 -731 keV).	63
Table 5.2	Ray count Rate for all calibration material in variant detector-source separation distances in gamma energy range (180 -480 keV).	65
Table 5.3	Gamma Ray count Rate of ¹³⁷ Cs detected for field measurement in Beit Fajjar over Terra Rossa soil and for two distances between the detector and the source.	73
Table 5.4	Results of bulk density measurements at Al-Quds University site. Detector-source distance is 20 cm. Time of measurement is 3 minutes.	76

List of Figures

		Page
Figure 1.1	Commercial device of gamma ray spectroscopy, parts that are common to all nuclear devices are shown	4
Figure 1.2	The cylinder of core method before inserting in the soil and after.	11
Figure 1.3	A hole digging in purpose to measure soil bulk density in excavation method.	13
Figure 1.4	A hole lined by the plastic and fixed by rocks to filled with water for volume measurement in excavation method.	14
Figure 2.1	Principle of gamma ray attenuation method.	19
Figure 3.1	A schematic representation of the photoelectric absorption process.	26
Figure 3.2	A schematic representation of Compton scattering.	28
Figure 3.4	Ideal photopeak in ideal gamma ray spectrum.	30
Figure 3.5	Ideal gamma ray spectrum show the photopeak and the Compton plateau. called the Compton edge. E_γ is the energy of the gamma-ray and m_0c^2 is the rest energy of the electron. This maximum energy transfer corresponds to an angle of scattering of the gamma-ray through 180° .	31
Figure 3.6	A Typical Gamma-Ray Spectrum collected using Gamma-Ray Spectrometer with NaI (Tl) detector.	32
Figure 3.7	Diagram showing the basic geometry of gamma ray backscattering density gauge.	37

Figure 4.1	Schematic diagram illustrating the electronic setup of detection system used to acquire the data.	39
Figure 4.2	A box from wood assembled for the purpose of calibration.	39
Figure 4.3	Wood box filled with sand as a calibration material.	47
Figure 4.4	Gamma ray backscattering spectroscopy system with detector placed with face down and the shielded source placed 10 cm away from the detector.	48
Figure 4.5	The field measurement geometry in Beit Fajjar.	50
Figure 4.6	Gamma ray backscattering spectroscopy applied on Terra Rossa soil field in Beit Fijar valley.	51
Figure 4. 7	held in Al-Quds University in area with Terra Rossa soil near the engineering faculty.	52
Figure 5.1	Gamma ray spectrum of ^{137}Cs source. Detector NaI(Tl) and radiation source are located on the top of the Terra Rossa calibration material in a wood box. Detector- source Distance is 10 cm.	55
Figure 5.2	Gamma ray spectrum of ^{137}Cs source. Detector NaI(Tl) and radiation source are located on the top of the Terra Rossa calibration material in a wood box. Detector- source Distance is 15 cm.	56
Figure 5.3	Gamma ray spectrum of ^{137}Cs source. Detector NaI(Tl) and radiation source are located on the top of the Terra Rossa calibration material in a wood box. Detector- source Distance is 20 cm.	57

Figure 5.4	Gamma ray spectrum of ^{137}Cs source. Detector NaI(Tl) and radiation source are located on the top of the Terra Rossa calibration material in a wood box. Detector- source Distance is 25 cm.	57
Figure 5.5	Gamma ray spectrum of ^{137}Cs source. Detector NaI(Tl) and radiation source are located on the top of the Terra Rossa calibration material in a wood box. Detector- source Distance is 30 cm.	55
Figure 5.6	Gamma ray spectra of ^{137}Cs source. Detector NaI(Tl) and radiation source are located on the top of the Terra Rossa calibration material in a wood box. Various detector- source Distance are used.	59
Figure 5.7	Gamma ray spectra of ^{137}Cs source. Detector NaI(Tl) and radiation source are located on the top of the lime stone (powder) calibration material in a wood box. Various detector- source Distance from 0 to 30 are used.	60
Figure 5.8	Gamma ray spectra of ^{137}Cs source. Detector NaI(Tl) and radiation source are located on the top of the sand calibration material in a wood box. Various detector- source Distance from 0 to 30 are used.	61
Figure 5.9	Gamma ray detected count rate as a function of different materials densities in the energy range of 250 – 730 KeV.	64
Figure 5.10	Gamma ray detected count rate as a function of different material densities in the energy range of 180 – 480 KeV.	66

Figure 5.11	Material density Vs count rate in gamma range of (180-480 KeV), with using 10 cm as detector-source separation distance.	68
Figure 5.12	Measured bulk density Vs count rate in gamma range of (250-730 KeV), with using 10 cm as detector-source separation distance.	69
Figure 5.13	Measured bulk density Vs count rate in gamma range of (180-480 KeV), with using 20 cm as detector-source separation distance.	70
Figure 5.14	Measured bulk density Vs count rate in gamma range of (250- 730 KeV), with using 20 cm as detector-source separation distance, the best fit line and its equation included.	71
Figure 5.15	Terra Rossa soil measurements in Beit Fajjar using 10 and 20 cm as a detector-source separation distances.	72
Figure 5.16	A comparison between the Count Rate of backscattered gamma ray emitted from ^{137}Cs and measured by a scintillation detector of the Terra Rossa in the calibration box and in the field with two detector-source separation distance of 10 and 20 cm.	73
Figure 5.17	A comparison between the gamma ray backscattered count rate spectra of same type of soil in Al-Quds University in dry and wet case.	78

Figure 5.18	The Count Rate in dry and wet case with using 10 and 20 cm as detector-source separation distance.	79
Figure 5.19	The Count Rate of another type of soil in dry and wet case with using 10 and 20 cm as detector-source separation distance.	80

Definition and Abbreviations:

Backscattering: The process of scattering or deflection into the sensitive volume of a measuring instrument radiation that originally had no motion in that direction. The process is dependent on the nature of the mounting material, the shield surrounding the sample and the detector, the nature of the sample, the type of energy of the radiation, and the geometry.

Channel: One of an MCA's memory locations for storage of a specific level of energy or division of time.

Compton Scattering: Elastic scattering of photons in materials, resulting in a loss of some of the photon's energy.

Count: A single detected event or the total number of events registered by a detection system.

Detector: A device sensitive to radiation which produces a current or voltage pulse which may or may not correspond to the energy deposited by an individual photon or particle.

Full Energy Peak: The peak in an energy spectrum of X-ray or gamma-ray photons that occurs when the full energy of the incident photon is absorbed by the detector.

KeV (Kilo Electron Volt): One thousand electron volts.

Multi Channel Analyzer (MCA): An instrument which collects, stores and analyzes time-correlated or energy-correlated events.

Pair Production: Creation of an electron-positron pair by gamma ray interaction in the field of a nucleus. For this process to be possible, the gamma ray's energy must exceed 1.022 MeV, twice the rest mass of an electron.

Peak: A statistical distribution of digitized energy data for a single energy.

Photomultiplier Tube (PMH): A device for amplifying the flashes of light produced by a scintillator.

Photopeak: See Peak.

Radiation: The emission or propagation of energy through matter or space by electromagnetic disturbances which display both wave-like and particle-like behavior. Though in this context the “particles” are known as photons, the term radiation has been extended to include streams of fast-moving particles. Nuclear radiation includes alpha particles, beta particles, gamma rays and free neutrons emitted from an atomic nucleus during decay.

Scattering: A process that changes a particle's trajectory. Scattering is caused by particle collision with atoms, nuclei and other particles or by interaction with electric or magnetic fields. If there is no change in the total kinetic energy of the system, the process is called elastic scattering. If the total kinetic energy changes due to a change in internal energy, the process is called inelastic scattering. See also backscattering.

Scintillator : A type of detector which produces a flash of light as the result of an ionizing event.

Spectrum : A distribution of radiation intensity as a function of energy or time.

Spectrometer: A device used to count an emission of radiation of specific energy or range of energies to the exclusion of all other energies. See also multichannel analyzer.

X-Ray: A penetrating form of electromagnetic radiation emitted during electron transition in an atom to a lower energy state; usually when outer orbital electrons give up some energy to replace missing inner orbital electrons.

BD: Soil Bulk Density.

Chapter I

Soil bulk density

1.1 Introduction

The isotope and radiation techniques have become a newly established high-tech industry in the developed countries. They penetrate from traditional application into the forefront and a new field of modern science and technology such as life science and material science. In nuclear techniques, by using nuclear characteristics of isotopes (radioactivity decay and mass difference) physical, chemical and biological effects of ionizing radiation, the existence and state of material can be detected, and their movement and behavior can be traced. So that information of material is acquired.

Nuclear technique as a sensitive means of detecting information can hardly be replaced by other sensing means (e.g., sound, heat, light, force, moisture, gas and chemical); therefore, it holds a very important position among techniques for information acquisition.

Nuclear technique, as a means of material modification or processing, is realized through physical, chemical and biological effects, which are created by interaction between ionizing radiation and the material.

Non-destructive testing of engineering components is a prime requirement of a quality control programme before putting them into service. Several techniques are available for nondestructive inspection, such as radiography, ultrasonic testing, eddy current testing and magnetic flaw detection. In all the techniques, scanning energy, in different forms such as electromagnetic waves, ultrasound waves, electrical energy, polarized light, are applied to the component under test and their interaction with a flaw is recorded and later this signal is analyzed to extract information. It is known that each technique has its limitations. For example, magnetic particle inspection is limited to ferromagnetic material, eddy current testing is applicable to electrically conducting materials, radiography is less sensitive in detecting planar flaws. Therefore, newer methods are emerging in the field of nondestructive inspection technology for specific requirements. Infrared thermography, holography, neutron radiography, Compton scatter spectrometry are all such techniques. In the Compton scatter technique, material is scanned with a photon beam. This Compton scattered radiation provides useful information. In this paper, the use of Compton scatter radiation for the non-destructive evaluation of materials has been explored.

Gamma-source gauges have been successfully used in the industry applications, such as measuring:

- a. the thickness of metal sheets,
- b. the level of fluids in containers,
- c. the density of fluids,
- d. the analysis of two-component systems,
- e. measuring and controlling the thickness of rolled products such as paper, plastic, and metal

In soil science, nuclear technique also take place. Gamma Ray Backscattering Spectroscopy is one of these technique.

Gamma Ray Backscattering Spectroscopy utilizes a gamma ray source usually ^{137}Cs , to be emitted and pass through the investigated material. Part of gamma ray photons will be scattered back by the material's atoms, to be then detected by the scintillation detector. The information from the Compton backscattered photons will analyzed by using special software of Genie 2000 from Canberra.

That system is available commercially as a box that contains the gamma ray source and the detector, as shown in Fig.(1.1).

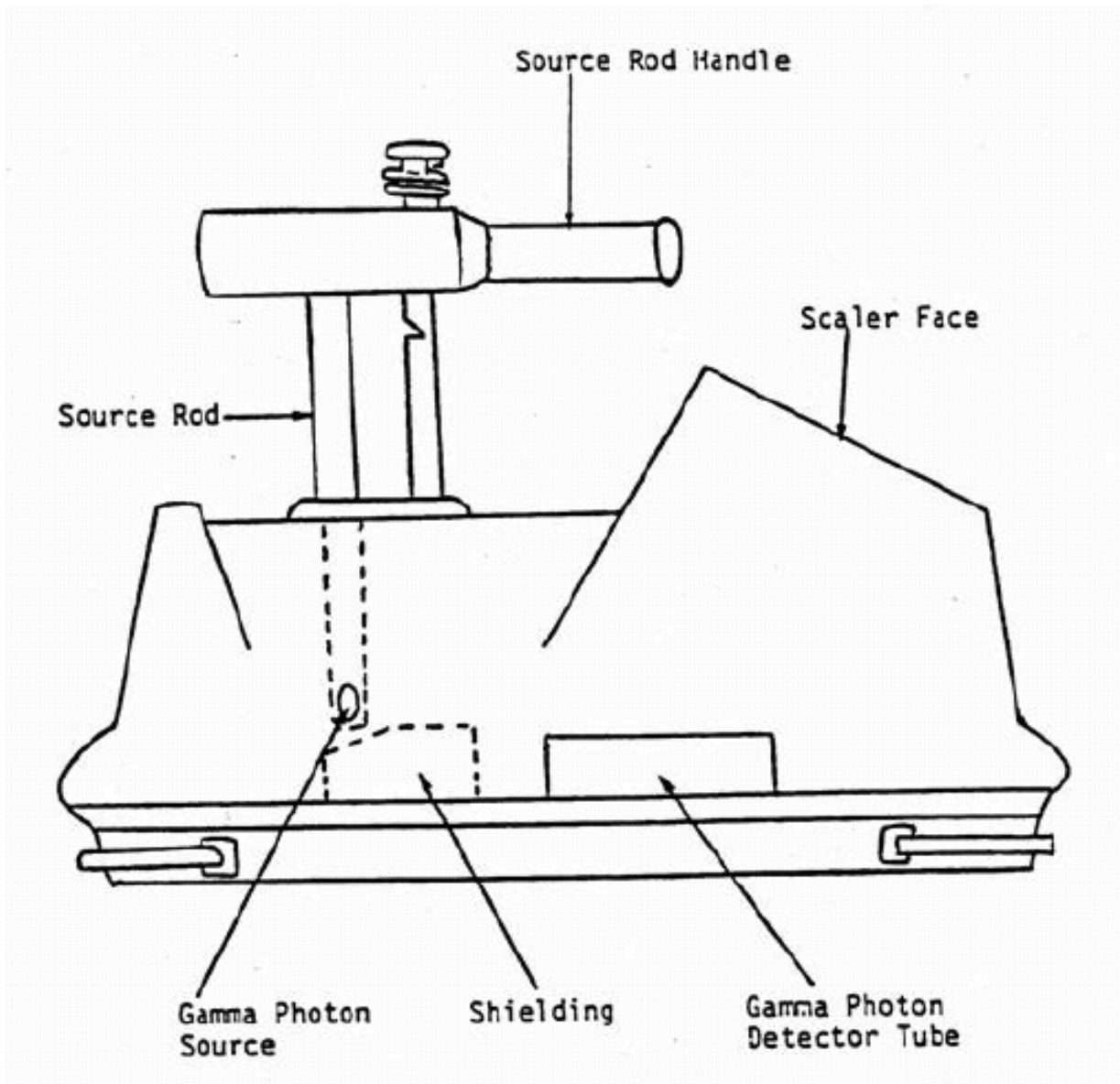

Figure (1.1): Commercial device of gamma ray spectroscopy, parts that are common to all nuclear gauges are shown.

In this study, the same principle will be used, but in different design. Calibration blocks are also commercially available to reduce consumed time and reduce the effort but, as far as the study utilize a special calibration system as other studies mention but, using simple and available materials.

This study employs Gamma Ray Backscattering spectroscopy to measure soil bulk density, which is a very important prosperity in soil science. Calibration is done for the system and the calibration curve plot for the system to find out the mathematical relationship between Compton backscatter count rate of gamma ray and soil density. Then field measurement performed in order to measure soil bulk density. Other measurements are performed before and after rain to watch the changes in the Compton backscatter peak in the gamma spectrum and so the changes in the count rate.

1.2 Importance of soil bulk density determination in soil science

Soil bulk density is an expression of the mass to volume relationship or dry mass to volume of the sample. Bulk density is expressed as Mega gram per meter cubic (Mg / m^3) or gram per centimeter cube (g / cc).

$$\text{soil bulk density } (\text{g} / \text{cm}^3) = \frac{\text{oven dry weight of soil}}{\text{volum of soil}} \quad (\text{Eq 1.1})$$

Soil bulk density takes into account the total soil volume (the space occupied by the solid particles plus the space occupied by the air of the pores or pore space) (Macros and Reni, 1999).

Soil Bulk Density (BD) plays an important role in determining if the soil has the physical characteristics that necessary for plant growth, building foundations or other uses. In soil science, measuring soil bulk density will enable the calculation of other physical and chemical properties. By calculating soil bulk density, we can calculate soil compaction. Compaction is a change in soil structure, not just an increase in soil density. Healthy soils have a diversity of pore sizes, while compacted soils have mostly small pores (university of Minnesota, 2002) an increase in BD indicates that movement of air and water within the soil has been reduced, and that the soil may be less favorable for plant growth or be more likely to erode (Miller. R. et al, 2001) so measuring soil compaction is important in agricultural activity and in construction application.

Soil porosity can be calculated too. Porosity is pore volume expressed as a fraction of total soil volume. Porosity can be calculated if bulk and particle densities are known.

Gravimetric water content can also be calculated which is mass of water per mass of oven-dry soil, expressed as a percent, and volumetric water content which is volume of water per total volume of soil and is expressed as a fraction. Calculation of gravimetric water content and volumetric water content will lead to calculate the percentage saturation (amount of pores filled with water relative to total volume to pores) by using a proper equations. Therefore, bulk density is important in quantitative soil studies and construction engineering.

1.3 Environmental factors that affect soil bulk density

Soil bulk density highly depends on soil moisture, compaction, texture, depth and mineral and organic material content.

Soil structure and texture largely determine its bulk density. Soil structure refers to the arrangement of soil particles into secondary bodies called aggregates. Since fine-textured soils generally have more total pore space than coarse-textured soils, the finer soils also generally have lower bulk densities. Bulk density values of fine-textured soils commonly range from 1.0 to 1.3 g / cm³, while those of sandy soils range from about 1.3 to 1.7 g / cm³ (Bouma. J, 1982). Despite this general difference in bulk density between sandy and clayey soils, sandy soils are referred to as “light” and clayey soils as “heavy”. This terminology refers to relative ease of tillage, not typical bulk densities.

Soil compaction strongly alters soil bulk density. Soil compaction, due to traffic from machinery or livestock or due to natural processes, decreases soil pore space and, therefore, increases bulk density. Since clay particles are plate-like, clay soils can be readily compressed and molded. Such compressibility, together with the low bulk density of clay soils, allows for substantial increases in bulk density when clay soils are compacted. In contrast, sand grains cannot be molded together. Thus, compaction of sandy soils with relatively small porosities does not lead to as great of increase in bulk density as occurs when clay soils are compacted. Although fine-textured soils generally have lower bulk densities than coarse-textured soils, the opposite can be true in compacted soils.

Accumulation of organic matter in soil lowers bulk density in two ways. First, the particle density of organic matter is much less than those mineral particles. Secondly, and more importantly, organic matter promotes the formation and stabilization of soil aggregates. Due to interaggregate pore space the porosity of well-aggregated soil is greater than that of a poorly aggregated soil. Accordingly, bulk density is lower.

In general, bulk density determined by soil texture and modified by soil structure. Within any textural class a certain range in bulk density is expected and whether, within this range, bulk density is relatively low or high depends on the degree of structural development. Whereas texture is not affected by soil management, soil structure is a fragile property that can deteriorate with intensive cultivation, exposure to raindrops and machinery traffic.

Soil content alters the soil bulk density, for example, sandy soil has high density because of its texture with low pore spaces and the absence of organic material (which have low density). Sandy soil bulk density ranging from 1.2 to 1.8 Mg /m³. In another soil type as clayey or silt soils have lower bulk density, it can be low as 1.1g/cm³. Because of high organic material content, pore spaces and high degree of aggregation in its texture. Soil bulk density ranging from 1.0 to 2.0 Mg/m³ (Bouma. J, 1982).

Soil depth also affects the soil bulk density, as deep the soil as high the bulk density because of decreasing in the organic material content and decreasing the soil aggregation.

1.4 Soil Bulk Density Determination

To measure soil bulk density, several methods are introduced. They are divided into two main categories: sampling methods and radiation methods.

1.4.1 Sampling Methods

All sampling methods depend on taking the sample from the field to the lab, measuring its dry mass, then measuring its volume. The bulk density measurement should be performed at the soil surface and/or in a compacted zone if one is present. Measure bulk density near (between 1 and 2 feet) the site of the respiration and infiltration tests. To get more representative soil bulk density measurements of the area, additional samples may be taken.

The ways to achieve that are different, so there are many different ways of sampling methods:

- a. Clod method.
- b. Core method.
- c. Excavation method.

a. Core Method

Core method depends on taking a sample from the field by using a special tools of cylinder with known diameters and garden trowel, flat-bladed knife, sealable bags and marker pen, to remove the sample from its field as shown in Fig.(1.1). In the field, the cylinder pushing into the soil and the depth of it should be exactly determined for an accurate soil volume measurement, and then carefully lift the cylinder out to avoid any soil loss. Excess soil should be removed by using the flat-bladed knife and then place the sample in bag and label it. In the lab, the sample should be weighed, then be dried into a microwave and then be weighed again to calculate its water content if it is requested.

Disadvantages of core method are that the soil will maintain in its natural conditions, if it is handled carefully. Core method have a lot of disadvantages, in this method the samples are easy to disturb, the transportation of the sample is consuming of time and effort especially when a big number of samples is requested which is better to have an accurate calculations. In the field, having an aggregate in the sample will be a problem.



a.

b.

Figure (1.2): The cylinder of core method before inserting in the soil and after.

Using this method, soil bulk density is determined as follows:

$$BD = \frac{(\text{mass of soil} + \text{mass of core}) - (\text{mass of core})}{\text{volume of core}} \quad (\text{Eq 1.2}).$$

b. Clod Method

Clod method uses large soil peds or clods. Clod volume is determined by pouring the soil into a graduated cylinder and measuring the volume that it occupies. The problem with this procedure is that structural aggregates may be crushed or compacted once they are removed from the soil and placed into the cylinder. A better procedure is one in which the aggregates could be removed from the soil and frozen exactly the way they were in the soil. Plastic fixatives enable us to do this.

A large aggregate has been removed from the soil and is being fixed by dipping it into a saran solution. This will make the clod impervious to water. Weight of the clump of soil can be obtained by hanging it on the balance or placing it on the metal weighing tray.

The volume of the clod also needs to be determined. This can be obtained by weighing the sample again. This time the sample only will be in water. The weight of the sample now will be less, since the sample will be buoyed up by the amount of water it is displacing. Thus, by subtracting the weight of the clod in water from its weight in air, we obtain the weight of the water displaced by the clod, which equals the volume of water displaced by the clod (because 1 cm³ of

water =1 gm. of water) and is equal to the volume of the soil clod. By clod method BD is determined as:

$$BD = \frac{\text{mass of cold}}{\text{volume of water displaced}} \quad (\text{Eq 1.3}).$$

c. Excavation Method

This method is to be used when rocks or gravels prevent sampling bulk density by the core method, so it is good for the heterogeneous soil. The soil in this method is removed from the field and filled in a plastic bag as illustrated in Fig.(1.2) below.



Figure (1.3): A hole digging in purpose to measure soil bulk density in excavation method.

The lifted hole should be lined with plastic wrap as shown in Fig.(1.3). Some excess plastic wrap is lifted around the edge of the hole. Sieved rocks are placed and grveled carefully in the center of the hole on top of the plastic wrap. The pile of rocks must not protrude above the level of the soil surface.



Figure (1.4): A hole lined by the plastic and fixed by rocks to fill with water for volume measurement in excavation method.

Soil's bag transported to the lab to be weighed then dried and weighed again to calculate the moisture content.

Water added to the hole using the 140 cc syringe to keep track of how much water is needed to fill the lined hole. The level of the water should be even with the soil surface. The amount of water represents the volume of the soil removed.

Excavation method is good for the heterogeneous soil rather than core and clod methods. On the other hand, this method has a disadvantage, that is, it is a time consuming method. The worst disadvantage for all the sampling method is that all are destructive methods and so repeating the sampling procedure for the same site is impossible.

Chapter II

Radiation Methods for Soil Bulk Density Determination

2.1 Types of Radiation Methods for measuring soil bulk density:

Radiation methods utilize the emission and detection of gamma rays for the measurement of the density of a material.

Gamma ray is a form of high-energy radiation, which readily penetrates most materials. In the transmission of Gamma ray between a source and detector, a proportion of these rays will be absorbed and scattered in accordance with the density of the material between the source and detector. As the density of this material increased, the number of absorbed and scattered gamma ray increase and the number reach the detector decrease. A relationship then exists between the detected gamma radiation (backscatter or transmission) and the density of the material.

The radiation method used for measuring soil density has several advantages over other related laboratory techniques:

- (1) It yields an in-situ evaluation of soil density.
- (2) It causes minimum disturbance of the soil.
- (3) It requires a relatively short measurement time.
- (4) It is more applicable for deeper subsoil determinations because it requires minimal excavation.

- (5) It is a nondestructive technique because continuous or repeated measurements can be performed at the same spot.

Radiation methods also have some disadvantages compared with the other methods. Because it is a more sophisticated technique, it requires expensive equipment and highly trained operators who must be able to handle the frequent calibration procedures, the electronics, and the sampling equipment. The system operator has to train on the radiation aspects and radiological protection procedures of the entire operation.

There are two basic methods of radiation methods utilizing radiation in soil bulk density measurements:

1. Transmission method.
2. Backscatter method.

2.1.1 Transmission Method:

Transmission method is one of the radiation methods used in measuring soil bulk density. It is referred to as a surface nuclear gauge SNG. "Over the past 25 years, the use of SNGs has become increasingly common on construction sites. The SNG was developed for quality control of sub grade and base material compaction during road construction" (Thomas B., May 2001). "Because the instrument is currently in use on construction sites, SNGs has also been used as an alternative to traditional excavation methods for determining bulk densities" (Thomas B., May 2001).

"Alberty et al. (1984) used a nuclear densitometer to measure bulk density on construction sites. The nuclear densitometer was easy to use and allowed rapid determination of soil bulk density with immediate readout" (Thomas B., May 2001). "The limitations to its uses by the landscape industry were the expense of purchase, health risks associated with nuclear radiation and the need for a licensed operator" (Thomas B., May 2001).

Transmission method is used frequently on construction sites by road and building technicians. Transmission method's electronic components are placed on the soil surface when measuring the wet density of the soil. The gamma source is lowered into the soil while the detector is located within the instrument. Gamma rays will reflect on almost everything in the soil, including water. When a gamma ray penetrates a material, the beam can be absorbed by the material, be deflected (could be deflected several times) but continue in a different direction with a lower speed, or the beam will penetrate the material without deflection or absorption. "Although it is impossible to measure the exact reaction of a beam through a material, it is possible to calculate the percentage of a source that is absorbed, deflected, or transmitted through the material" (Thomas B., May 2001).

The denser the soil, the fewer reflected waves are counted by the detector. By calibrating the detector, the number of counts can be translated into a measurement of the wet soil bulk density" (Thomas B., May 2001).

2.1.1.1 Theory of Radiation Transmission Method:

What is known Beer's law establishes the relationship between the attenuated radiation intensity by a target and other parameters of the system. It can be written as:

$$I = I_0 \exp(-\mu\rho\chi) \quad (\text{Eq 2.1})$$

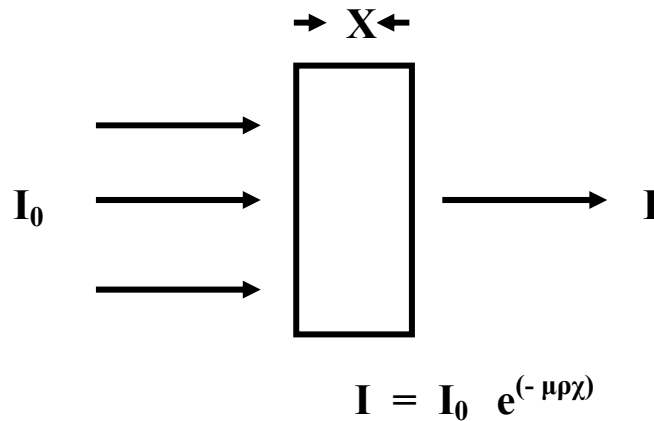

Figure (2.1): Principle of gamma ray attenuation method.

where I_0 is : incident gamma ray beam intensity (cont s-1) , and

I is : emergent gamma ray beam intensities (cont s-1),

μ is: the mass attenuation coefficient of the target ($\text{m}^2 \text{kg}^{-1}$),

ρ is: the density of the target (kg m^{-3}) and χ is the thickness of the target (m).

Gamma ray transmission increases with increasing of gamma ray energy and decreases with increasing material thickness.

Transmission method gives good accuracy, least composition error and least surface roughness error. It can be used for testing over a range of depths from 10 cm to 30 cm, which need a borehole to dig.

Transmission method is easy, fast and accurate but it has a disadvantage that it is need a hole to dig so, it is partially destructive and the operator should know the mass attenuation coefficient, and the thickness of the absorber material.

2.1.2 Backscattering Method:

Backscatter is the amount of radiation that is been deflected by the material and is measured by placing the detector and the source on the surface of the material.

The backscatter technique relies on the detection and analysis of Compton scattered photons at the surface of the bulk material that is being irradiated (one measurement position) by a source placed some distance away (D), in another words a counter in the device established the number of Gamma ray that backscattered. The returning rays are proportional to the density.

Backscatter technique is useful for semi-infinite bulk materials such as soil or concrete surfaces or boreholes where the linear geometry of source sample and detector is not achievable. The technique is also useful for slabs or the walls of long tubes where only one side of the material is accessible. The backscatter method is also attractive in that it requires no moving parts other than deployment to the surface of the material (Ball. A, 1997).

Several characteristics of the backscatter technique are critical. First, it is more sensitive to the material nearest the surface than to material farther down. Typically, 80% to 95% of the detector count comes from the top 5cm; little comes from below 10 cm. Although nuclear gauges operating in the backscatter mode get most of their count from the top 5 cm, they still get 5% to 20% from the 5 to 10 cm range.

The second important characteristic is the system's sensitivity to surface roughness.

As with any other test method, the user must be concerned with precision how reputable are a gauge's readings at a given location. For nuclear detector's, precision is better when the returning Gamma ray are counted for a longer period of time. Typically, a one-minute count would have a precision of +/- 8.0 Kg/ m³. A four-minute count would be accurate to +/- 0.4 Kg/ m³.

The limitations for nuclear testing equipment are the precautions that must be observed when handling radioactive material, and the fact that false readings are sometimes obtained from organic soils or materials high in salt content.

Calculation shows that 50% of the total response of the instrument originates from 14% of the volume of the soil from a hemisphere of radius D, D being the source-detector separation. Since the response pattern of this type of backscatter gauge is far from uniform, it is necessary to consider the response patterns in planning the conditions of experiments involving these systems to obtain the highest sensitivity. This is of particular importance in studying soils of a heterogeneous nature (G.devlin, D.taylor, 1970).

In comparison between backscatter and transmission technique, transmission technique can reach a depth more than backscatter, for example if one of the detector or the source put into depth of 30 cm the readings will be accepted. In this technique, we can make a hole for a source or in some studies; we can place the detector and the source on the surface. Backscatter method is truly non destructive method.

In backscatter technique, it is good to shield the source and detector from each other so that direct radiation cannot pass from the source to the detector. On the other hand, gamma ray from the source can pass downwards into the ground and a proportion of these gamma ray photons will scatter onto the detector, the response is a function of the density of the section of the ground under test.

Such devices are widely used in well logging, soil science and in the manufacturing and construction industries.

Chapter III

Backscattering Gamma Ray Spectroscopy

3.1 Gamma ray

Gamma rays (denoted as γ) are a form of electromagnetic radiation or light emission of frequencies produced by sub-atomic particle interactions, such as electron-positron annihilation or radioactive decay. Gamma rays are generally characterized as electromagnetic radiation having the highest frequency and energy, and also the shortest wavelength (below about 10 picometer), within the electromagnetic spectrum. Gamma rays consist of high-energy photons with energies above about 100 keV.

Unlike light, gamma rays can penetrate various materials. Several centimeters of soil could be penetrating without disruption, although gamma rays will reflect on almost everything in the soil, including water.

3.2 Interactions of gamma ray with matter

Knowledge of gamma-ray interactions is important to the nondestructive essayists in order to understand gamma-ray detection and attenuation.

Gamma ray interact with the detector in many ways caused the gamma ray spectrum appear in a special shape with gamma energy appear as pulse height distribution.

To understand the pulse height distribution associated with the gamma rays from a radioactive source, it is important to realize that only a fraction of the gamma rays interact with the detector; many do not interact at all and simply pass right through. Furthermore, when a gamma does interact, the size of the pulse from the detector depends on whether all or only part of the gamma energy is deposited in it.

Gamma rays of interest in this work fall in the range from 100 KeV to about 1 MeV. Gamma ray interacts with material in many ways, which is the reason in the shape of the gamma ray spectrum that appears in the monitors. Gamma ray interacts with materials in three main ways:

1. Photoelectric absorption.
2. Compton scattering.
3. And pair production.

3.2.1 photoelectric absorption:

In this type of interaction gamma ray loses all of its energy in one interaction with electron around the atom usually K shell electron cause it's ejecting from the atom with a kinetic energy equal to the incidence gamma ray minus its binding energy.

$$E_e = E_\gamma - E_b \quad (\text{Eq 3.1}).$$

Photoelectric effect much common with gamma energy below 50KeV, but it less important at higher energy because photo effect depend on gamma ray energy, Atomic number (Z) of the absorber and the binding energy.

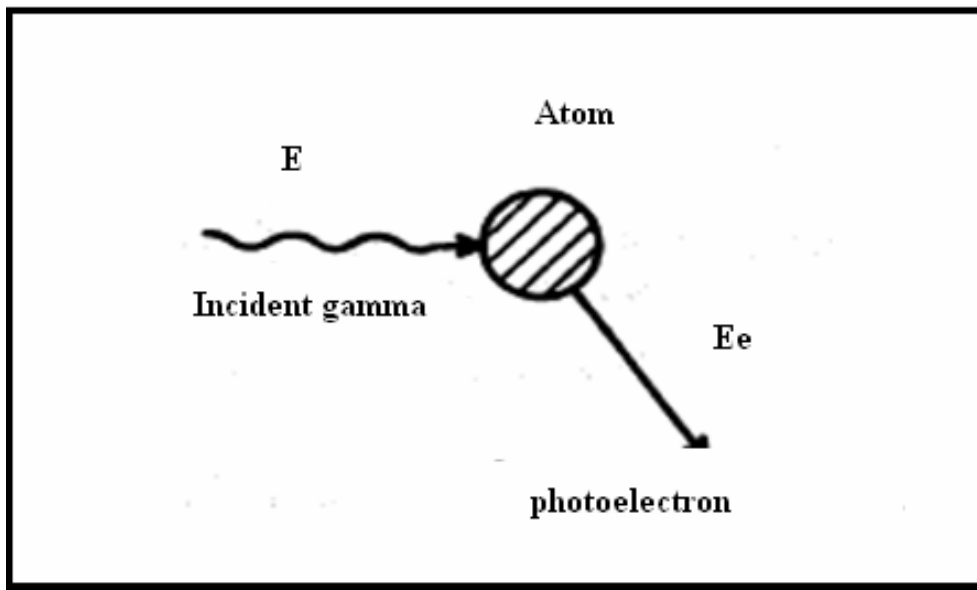

Figure (3.1): A schematic representation of the photoelectric absorption process.

3.2.2 Compton Scattering:

Compton scattering is the process whereby a gamma ray interacts with a free or weakly bound electron and transfers part of its energy to the electron. This interaction involves the outer, least tightly bound electrons in the scattering atom. The electron becomes a free electron with kinetic energy equal to the difference of the energy lost by the gamma ray and the electron binding energy, Gamma ray change it's direction after that, scattered gamma and free electron direction depend on the incident gamma ray (the angle between them depend on original energy).

Because the electron binding energy is very small compared to the gamma-ray energy, the kinetic energy of the electron is very nearly equal to the energy lost by the gamma ray:

$$E_e = E_\gamma - E' \quad (\text{Eq 3.2})$$

where E_e = energy of scattered electron

E_γ = energy of incident gamma ray

E' = energy of scattered gamma ray.

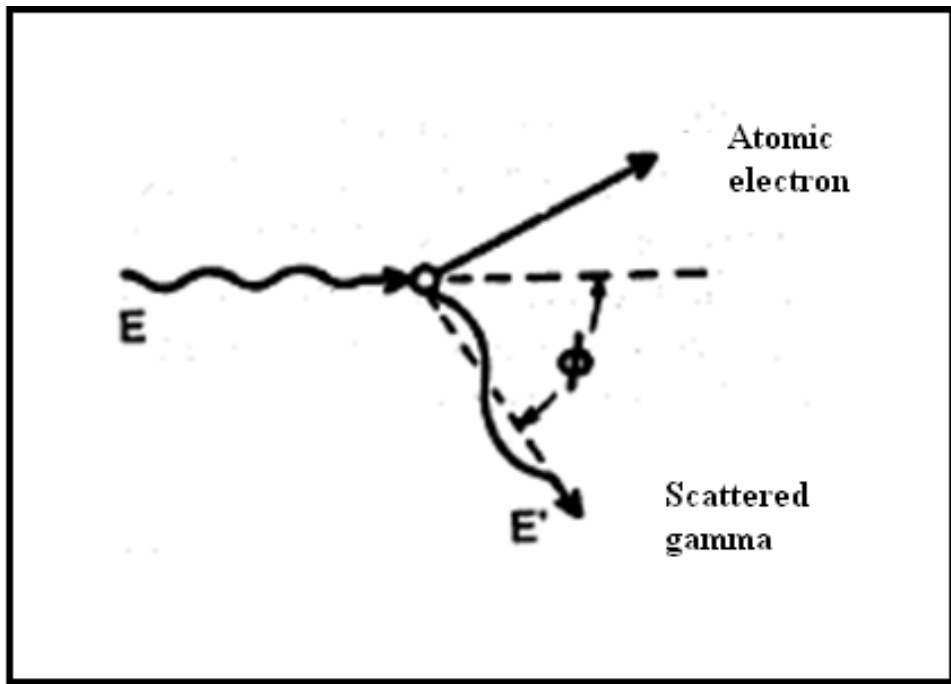

Figure (3.2): A schematic representation of Compton scattering.

Because Compton scattering involves the least tightly bound electrons, the nucleus has only a minor influence and the probability for interaction is nearly independent of atomic number. The interaction probability depends on the electron density, which is proportional to Z/A (where: Z is the atomic number and A is the mass number) and nearly constant for all materials. The Compton-scattering probability is a slowly varying function of gamma-ray energy. Compton scattering is common in the energy range of 100 KeV to 10 MeV.

3.2.3 Pair Production:

Gamma ray with energy of at least 1.022 MeV can create an electron-positron pair when it is under the influence of the strong electromagnetic field in the vicinity of a nucleus. In this interaction the nucleus receives a very small amount of recoil energy to conserve momentum, but the nucleus is otherwise unchanged and the gamma ray disappears. This interaction has a threshold of 1.022 MeV because that is the minimum energy required to create the electron and positron. If the gamma ray energy exceeds 1.022 MeV, the excess energy is shared between the electron and positron as kinetic energy. This interaction process is relatively unimportant for gamma ray backscattering spectroscopy because most important gamma-ray signatures are below 1.022 MeV.

3.3 Gamma Ray Spectrum

When a monoenergetic source of gamma-rays (e.g., ^{137}Cs) is placed near a scintillation detector, you expect ideally a spectrum, which is a single photopeak caused by the photoelectric effect in the NaI crystal as in Figure (3.4).

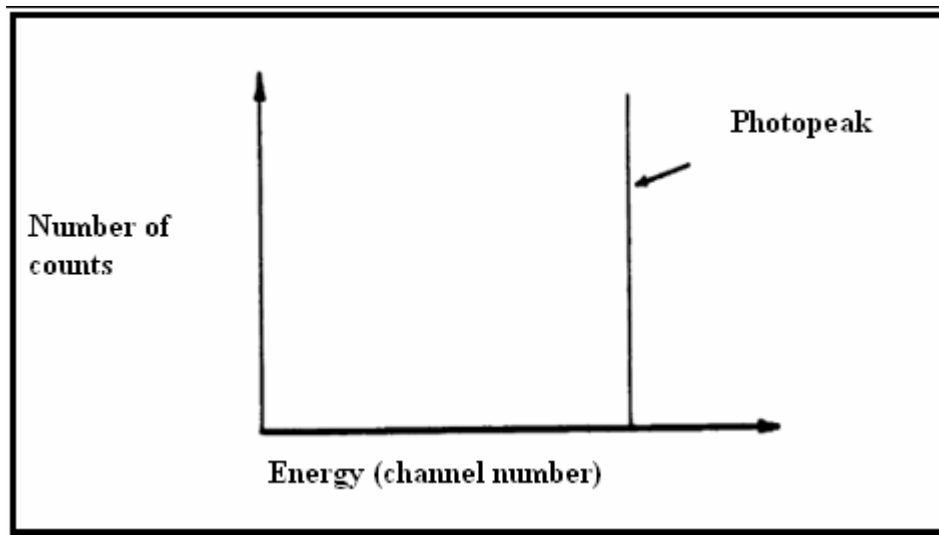

Figure (3.4): Ideal photopeak in ideal gamma ray spectrum

However, other processes take place by which gamma-ray energy is been absorbed, thus altering the spectrum shape. Because of the different ways of gamma ray interaction with matter, another shape is been produced.

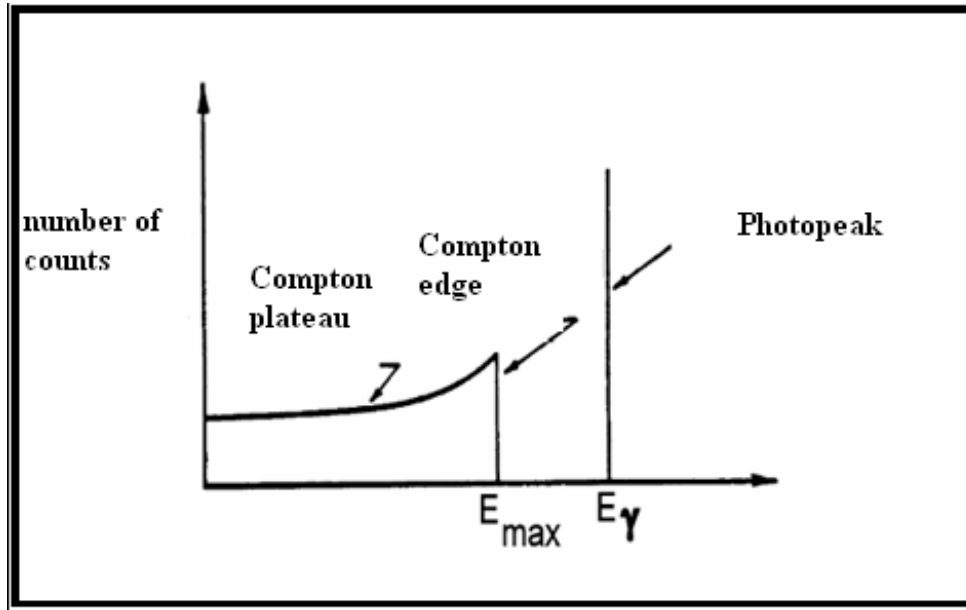

Figure (3.5): Ideal gamma ray spectrum show the photopeak and the compton plateau, called the Compton edge. E_{γ} is the energy of the gamma-ray and m_0c^2 is the rest energy of the electron. This maximum energy transfer corresponds to an angle of scattering of the gamma-ray through 180° .

It is good to remember that the spectrum you will be looking at in Fig. (3.5) is not really a gamma-ray spectrum but is the energy spectrum of the electrons that have received energy from the gamma rays. In addition, the features of the spectrum are not as sharp as previously indicated because of the fact that the number of electrons emitted from the photomultiplier photocathode as a result of the flash of light produced by the incoming gamma-ray is of the order of a few hundreds. This means that there is a significant statistical spread on the number of electrons emitted as a result of an individual interaction and this results in the smearing of the photopeak and Compton edge. The final spectrum for one gamma ray should be similar to that shown in Fig. (3.6).

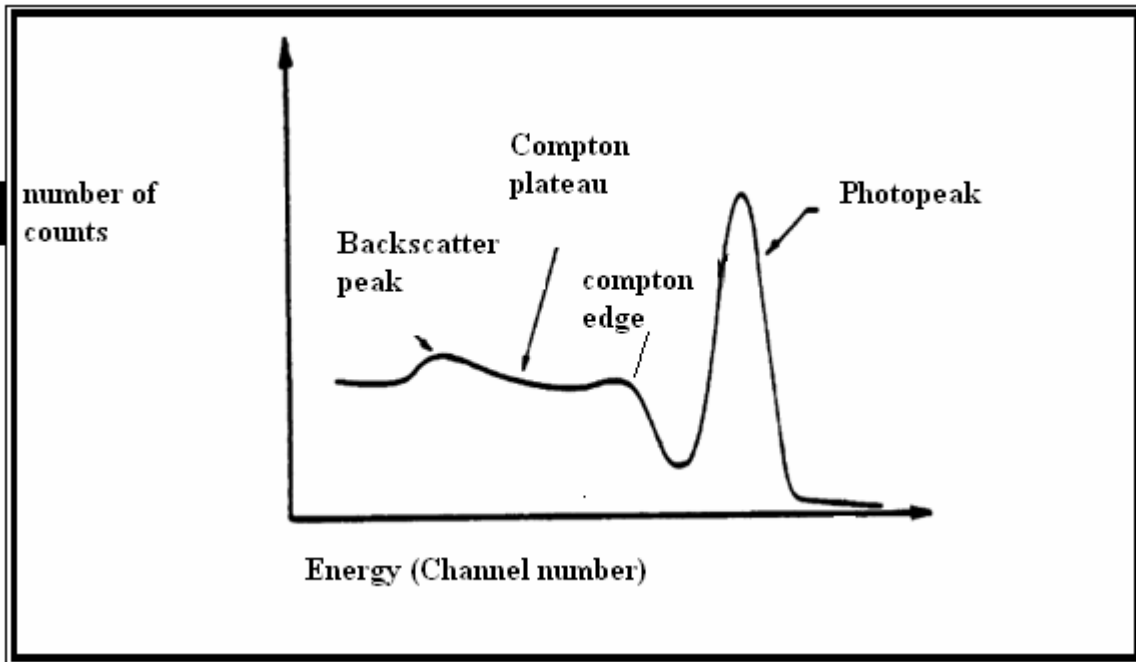

Figure (3.6): A Typical Gamma-Ray Spectrum collected using Gamma-Ray Spectrometer with NaI (Tl) detector.

Photopeak and Compton scattering interactions are the responsible interactions for the shape of the gamma ray spectrum. In photopeak, the gamma ray gives up all of its energy, and the resulting pulse falls in the full-energy peak. In most detectors, the photoelectron is stopping quickly in the active volume of the detector, which emits a small output pulse whose amplitude is proportional to the energy deposited by the photoelectron. Also Compton scattering that followed by photo-electric absorption contribute in the photopeak.

In the Compton interaction section there are three important areas, the Compton backscattering peak, Compton plateau and Compton edge.

When a gamma ray enters the crystal, instead of ejecting an electron from an atom, it may collide with a (more or less) free electron giving up only a part of its energy to the electron. If the scattered gamma ray escapes from the crystal then only part of the energy of the original gamma ray is left with the electron in the crystal. This results in a smaller amount of light and it is as if a gamma ray of smaller energy were completely absorbed in the crystal simple kinematics (conservation of energy and momentum) forbids the electron from receiving more kinetic energy than:

$$E_{\max} = \frac{2E_{\gamma}^2}{m_0 c^2 + 2E_{\gamma}} \quad (\text{Eq 3.3})$$

Where , E_{γ} : Is the energy of the gamma-ray.

$m_0 c^2$: Is the rest energy of the electron.

E_{\max} : This maximum energy transfer corresponds to an angle of scattering of the gamma-ray through 180° .

That energy appears in the gamma ray spectrum as a Compton edge.

Compton scattering is a fairly slowly varying function of angle and so there will be a distribution of Compton events of energy less than the Compton edge, that's which called Compton plateau .

Backscattering peak generated from the gamma rays that scattered back from the environment around the system and from the instrument's themselves that's photons sure have less energy than the full energy of the original gamma-ray.

3.4 Gamma Ray Backscattering Spectroscopy Theory

Theory of gamma ray backscattering spectroscopy come from the hole system component, it is come from, Compton effect while gamma ray interaction with matter, interactions in the scintillation detector and the principle of the multichannel analyzer.

The main idea of gamma ray backscattering spectroscopy depends on the processes of gamma ray interaction with material. The detected gamma ray will form gamma ray spectrum, which is a basket of information about the investigated material. Gamma rays interact with material by three main ways. The resulted gamma ray spectrum is actually been formed by that different ways of interaction, because those interactions occurred into the material so the spectrum from the beginning to end hold with it a lot of information about the material.

There are important sections in the spectrum, which they are, have the maximum energy and have a shape that make them easy to recognize, that sections are photo peak, backscattering peak, and Compton edge.

3.5 Basic Principles of Gamma - Ray Backscattering Spectroscopy

Gamma backscatter density spectroscopy used the Compton scattering of gamma ray photons in bulk material to measure density. Such devices are widely used in well logging, soil and the manufacturing and construction industries. Backscatter density gauges can be applied to semi – infinite bulk materials (such as rock or soil), boreholes or structures where the other side is inaccessible (the walls of long tubes, for example). Since the cross-section for Compton scattering is proportional to the number density of electrons, and the ratio of atomic mass to atomic number is 2.0, or nearly so, for all elements (except hydrogen) the backscattered count rate is a function of the bulk density.

Backscatter method involves placing the source and detector on the same side of the material to be measured (i.e. on the surface) the basic geometry is shown in Fig.(3.7). Gamma radiation emitted from the source must then be scattered back towards the detector if it is to be detected.

shielded radioactive source **detector**

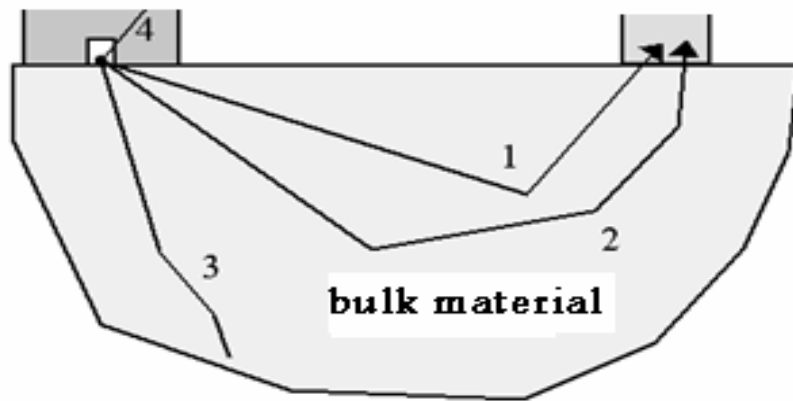

Figure (3.7):Diagram showing the basic geometry of gamma ray backscattering density gauge.

Gamma photons emitted from the source are either:

1. Detected having scattered once in the material.
2. Detected after multiple scattering.
3. Lost by scattering and absorption in the material.
4. Stopped by the source shielding.

3.5.1 Parameters Affecting Detected Count Rate for a Backscatter Densitometer:

1. The characteristics of the source: energy, activity and emission direction (collimation).
2. The characteristics of the detector, such as aperture size, field of view, efficiency, energy window and susceptibility to background radiation.
3. The source-detector separation (sonde length).
4. The scattering and absorption characteristics of the bulk material underneath the instrument.

If the parameters 1, 2, and 3 are fixed, so the count rate variation will be a result of density changing. "Count rate reaching a maximum at some critical value. Above the density the count rate of the scattered photons is been reduced by a lack of photons – fewer penetrate far enough into the material to scatter into the detector. Below the critical density the count rate is reduced by a lack of electrons- lower density." (Jonathan A., 1997).

Most practical densitometers use ^{137}Cs which emits gamma ray at 662 KeV, within the energy range where the Compton process dominates. It is desirable to use radioisotopes that emit mostly at a single energy; otherwise, source photons would encounter differing interaction cross- sections. The detector cannot distinguish between photons which, when originally emitted, had different energies. (Jonathan A., 1997).

Chapter IV

Methodology and Instrumentation

4.1 Instrumentation

4.1.1 Electronics:

The electronic system used in this study consists of NaL(Tl) scintillation Detector consist (Model 802), preamplifier (Model 2007/2007P), amplifier (Canberra Model 2020), multi channel analyzer (InSpector 2000 DSP) and a laptop computer.

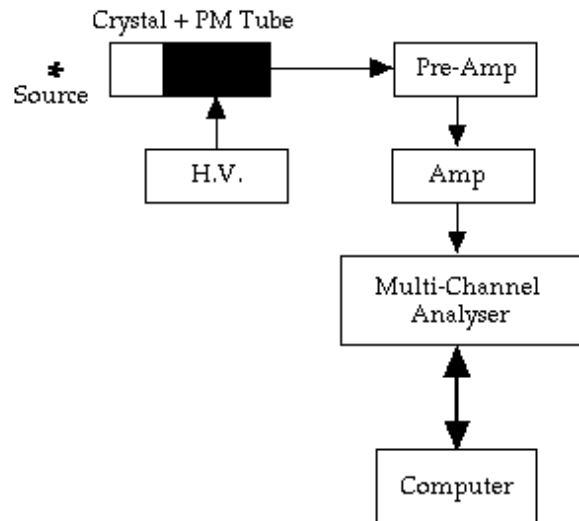

Figure(4.1) : Schematic diagram illustrating the electronic setup of detection system used to acquire the data.

4.1.2 Detector:

- **Scintillation Detector – Model 802**

Scintillation detector is the special detector for measuring gamma ray. The function of the detector is to convert radiation energy into an electrical signal. Scintillation detectors are very sensitive radiation instruments and are used in both portable and stationary.

The scintillation detector used in this work is Sodium Iodide NaI (Tl) (Model 208), its include a high resolution NaI (Tl) crystal (The high Z of iodine in NaI(Tl) crystals result in high efficiency for gamma-ray detection), a photomultiplier tube, an internal magnetic/light shield, an aluminum housing ,and a 14-pin connector.

NaI(Tl) detector has high efficiency and a long-term reliability and stability. The detector dimensions are 76.2 mm×76.2 mm (3”×3”) NaI activated with Thallium. The resolution of its crystal is 7.5% at 662 KeV energy of ¹³⁷Cs , from Canberra.

4.1.3 Multi Channel Analyzer (MCA):

The operation of the multi channel analyzer is based on the principle of converting an analog signal, which is the pulse amplitude into an equivalent digital number usually referred to as channel. After this is done the digital information will be stored in the memory to be displayed on the monitor. This activity is in principle carried out by the Analog To Digital Converter (ADC) (Knoll,2000). The pulses are collected ,stored according to pulse height in the ADC and a γ -ray spectrum is generated. Therefore the performance of the MCA is primarily dependent on the ADC. The results discussed in this work were measured using an MCA (InSpector 2000 DSP) with a PC using the Genie 2000 software program.

4.2 Genie 2000 Basic Spectroscopy Software

Genie 2000 Basic Spectroscopy Software (Canberra Inc., 2000); is a comprehensive environment for data acquisition, display and analysis in personal computers. It provides independent support for multiple detectors.

The counting procedure software provides a total environment for the application. In addition to taking standard measurements, the procedures provide a guided user interface for calibration operations, and quality control. Plus, under management level security, setup functions are provided.

Genie 2000 could do a Full gamma spectrum analysis, Interactive Spectral Analysis, Efficiency correction, Nuclide identification and quantification, Library Correlation NID Peak Locate, Interference correction and

weighted mean activity calculations, Parent/daughter decay correction, Background subtraction and reference peak correction, Minimum Detectable Activity (MDA) calculations, Patented true coincidence (Cascade) summing correction, Geometry composer for interactive definition of sample/detector parameters.

4.3 Calibration Materials of The Detection System

Different calibration materials are a prerequisite for nuclear gauge measurement of materials density. It allows the conversion of nuclear gauge data for material density measurement.

There are many materials could use in the calibration process, some studies used magnesium and aluminum metal cylinders and asphalt cylinder, another studies used granite, lime stone, and construction materials. Usually calibration done in the manufactures before using the system (Peterson. R, 1986).

In calibration process, to know the density of the calibration material is the most important thing, and it is better to be sealed to protect it from material leakage and undue changing in weight resulting from environmental factors or variation in moisture. Some manufactures did calibration using a fixed location marked on concrete floors or asphalt parking.

It is desirable to have a simple calibration process so that the system can be calibrated without the costly and cumbersome processes of shipping the gauge off-site for calibration, and to make it easy to calibrate the system any time we need. Calibration material should include a range of densities encountered with our field soil. In this study sand, red soil and limestone powder are used to calibrate the detection system.

4.3.2 Calibration Boxes:

Three wooden boxes were especially manufactured to perform calibration procedure used in this work, each boxes are 59 cm in length 42 cm in width, and 34 cm in height. Dimensions of the manufactured boxes were selected from the literature (Regimand, A., (1997)).

The most important thing when choosing the box dimension is to make the box represent an infinite volume to the instrument. The main idea of choosing this dimension is to make the calibration blocks big enough to situate the gamma source and the scintillation detector with a distance, which protect the maximum of gamma ray from escaping from the box.

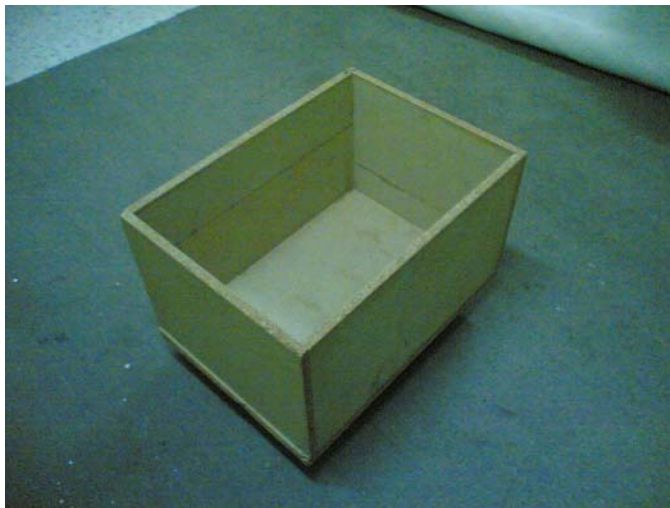

Figure (4.2): A box from wood assembled for the purpose of calibration.

4.3.3 Gamma-Ray Source:

^{137}Cs point source with 0.662 MeV primary gamma ray energy is used. ^{137}Cs is one of the most common radioisotopes used in industry. The most dominant interaction between ^{137}Cs gamma-ray range and materials atom is the Compton interaction, which make it the most appropriate for our study.

4.4 Gamma ray backscattering spectroscopy calibration:

As with other nuclear gauges, the gauge has to be calibrated to convert gamma ray counts to material bulk densities. Calibration process introduces a relationship between the MCA channel numbers and the radiation energy that is determined, which is necessary for analysis of radiation spectrum.

System calibration is a special calibration for the instruments in order to be fit for the field. So a relationship between the material density and the gamma ray detected will be easily introduced.

4.4.1 Calibration materials for density determination:

Three materials with different known densities are used for calibration process in this work. These materials with their densities are listed in the table (4.1) below.

Table (4.1): Materials with known densities that used for calibration of the nuclear detection system.

Calibration material	Density (g / cm ³)
Sand	1.6
Terrarosa (Pedo cal)	1.3
Limestone powder	1.55

4.4.2 Methodology of Calibration:

Calibration materials are filled into three wooden boxes of the same volume. Boxes filled to the top for all materials as shown in the Fig.(4.4) below.



Figure (4.3): Wood box filled with sand as a calibration material.

Boxes are placed in a suitable place, far from the sun ray and wind to avoid temperature fluctuation. The boxes shall be in a fixed location, which is at least one meter from any vertical projection, and sufficiently clear of other nuclear gauges or radiation sources to have no effect on nuclear gauge density measurement.

Measurement time is quite short it is 60s. This is in order to minimize the effect of background radiation and the temperature fluctuation. Material surface in calibration boxes is cleaned from any voids and covered by very thin layer of plastic to avoid sand leakage or causing any damage to the instruments.

Detector placed with face down, matched well to material surface and the ^{137}Cs source was shielded and placed at various distances from the detector (from 10 to 30 cm), that clear in Fig.(4.5).



Figure (4.4): Gamma ray backscattering spectroscopy system with detector placed with face down and the shielded source placed 10 cm away from the detector.

Detector – Source Separation Distance (D) varies to study the effect of the distance in the count rate and to find out the optimal separation distance to apply in the field. Measurement held with distance of 10 , 15 , 20 , 25 and 30 cm.

Measurements were performed for the three calibration materials with 5 different detector – source separation distances. A calibration curve was established for this calibration process to find the most suitable relationship between material's densities and the count rate, to apply on the field measurements.

4.5 Field Measurement Methodology

Test and actual field measurements are performed in Beit Fajjar and at various locations at Al_Quds University main camp in Abu-Dies. The geometry of measurement is shown in Fig.(4. 6).

In Beit Fajjar, the field measurement is performed on a Terra Rossa soil. At Al-Quds University the field measurements performed on two different types of soil. One near Engineering Faculty and the other near the theater area.



Figure(4.5): The field measurement geometry in Beit Fajjar.

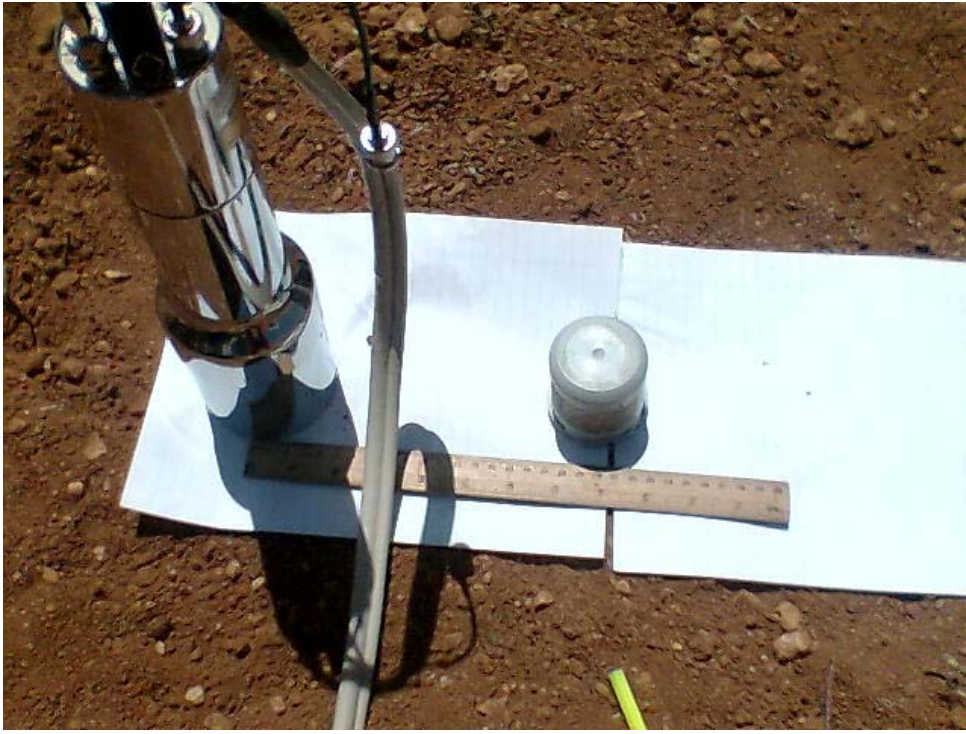

Figure(4.6): Gamma ray backscattering spectroscopy applied on Terra Rossa soil field in Beit Fajjar .

Then measurements were done in Al-Quds University in two locations, one with Terra Rossa soil, Fig.(4. 8), and the other with chalk soil. The sites of Terra Rossa soil fields in Beit Fijjar and in Al-Quds University are different from their texture and geological formation.



Figure (4.7): Measurements held in Al-Quds University in area with Terra Rossa soil near the engineering faculty.

All the previous field measurements were done in summer, and were conducted again in winter after rain for once to watch the rain effect on the gamma ray backscattering spectroscopy count rate, that is to see effect of water on the soil density.

Chapter V

Results and discussion

Calibration is performed to establish a relationship between NaI(Tl) detector spectra (count rate) to backscattering photons and the material density.

Three different materials, which have three different bulk densities, are used in this calibration process. They are sand (1.6 g / cm^3), lime stone powder (1.55 g / cm^3) and Terra Rossa soil with density of (1.3 g / cm^3). The three materials are filled in three wooden boxes which are constructed special for this purpose.

Two parts of the collected gamma ray spectra from ^{137}Cs are used for data analysis. One within energy range of Compton backscattering peak (180 – 480 KeV) and the another one within the energy range of (250 – 730 KeV) which include the Compton backscattering peak and the photo peak.

5.1 Optimization of Detector – Source Separation Distance

Gamma ray backscattering spectroscopy geometry include a separation distance between the detector and gamma ray source (detector-source separation distance) while using the system.

In this work, different distances are applied while calibration process to find out the best distance to use in the field. Distances of 10, 15, 20, 25 and 30 cm are used.

5.1.1 Gamma Ray Spectra That Collected for Terra Rossa :

Calibration process initiated with Terra Rossa (pedocal) soil calibration box's, with applied the five different detector- source separation distances. Spectra resulted from using the different distances are shown below.

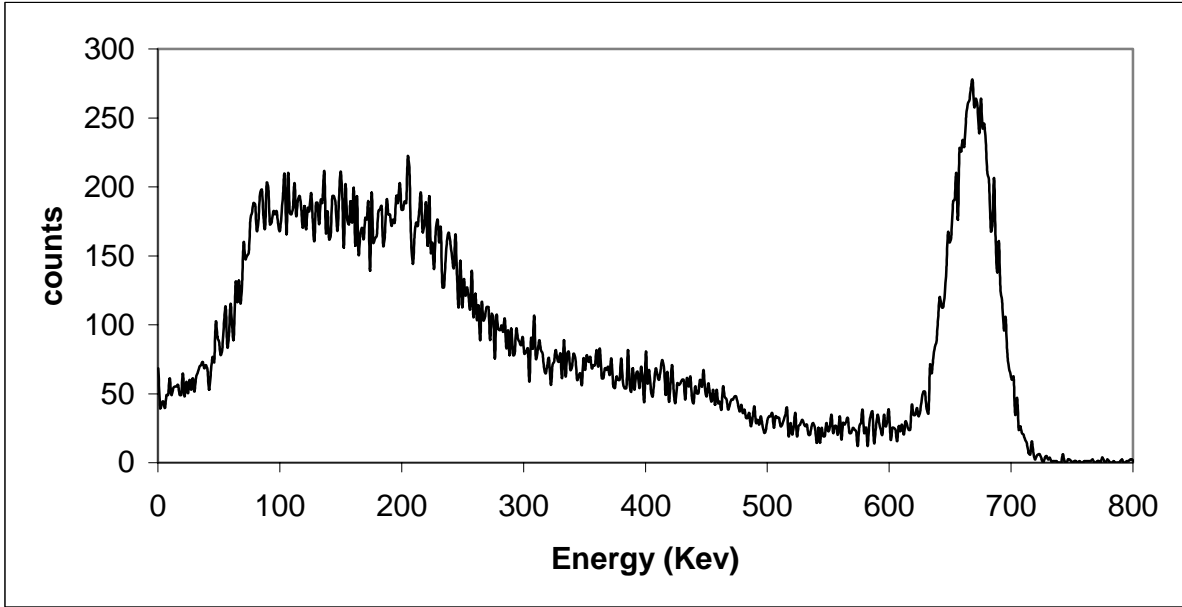

Figure (5.1): Gamma ray spectrum of ^{137}Cs source. Detector NaI(Tl) and radiation source are located on the top of the Terra Rossa calibration material in a wood box. Detector- source Distance is 10 cm.

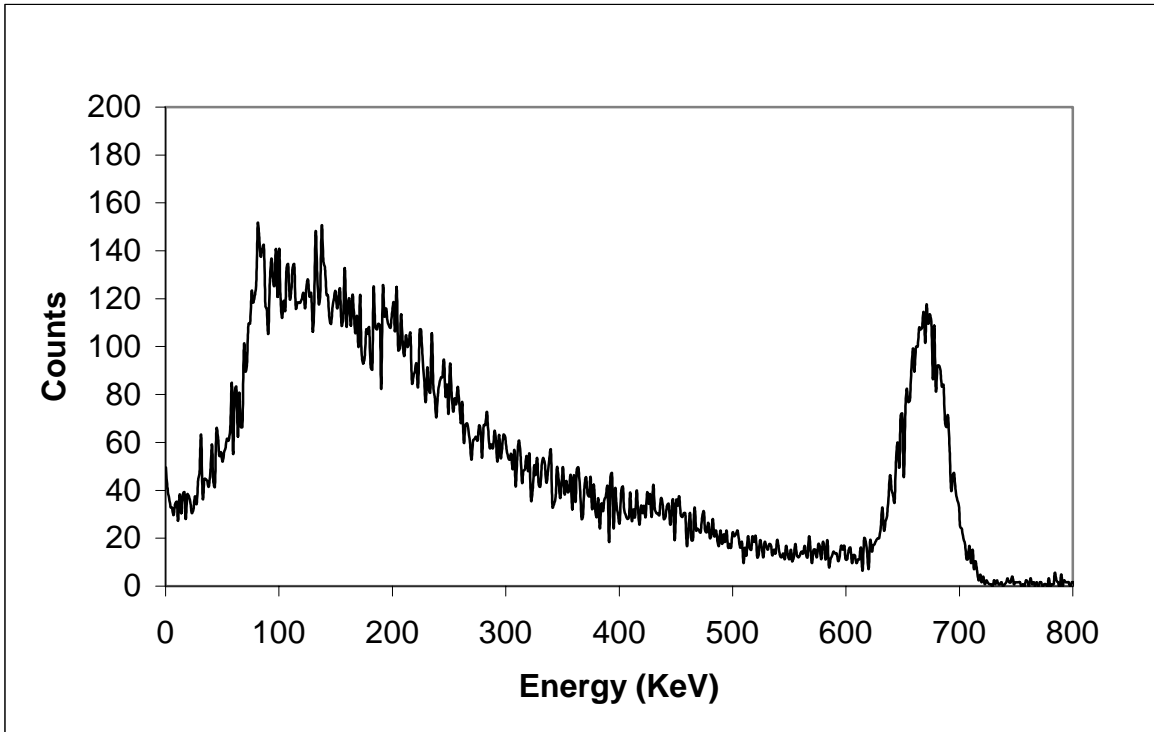

Figure (5.2): Gamma ray spectrum of ^{137}Cs source. Detector NaI(Tl) and radiation source are located on the top of the Terra Rossa calibration material in a wood box. Detector- source Distance is 15 cm.

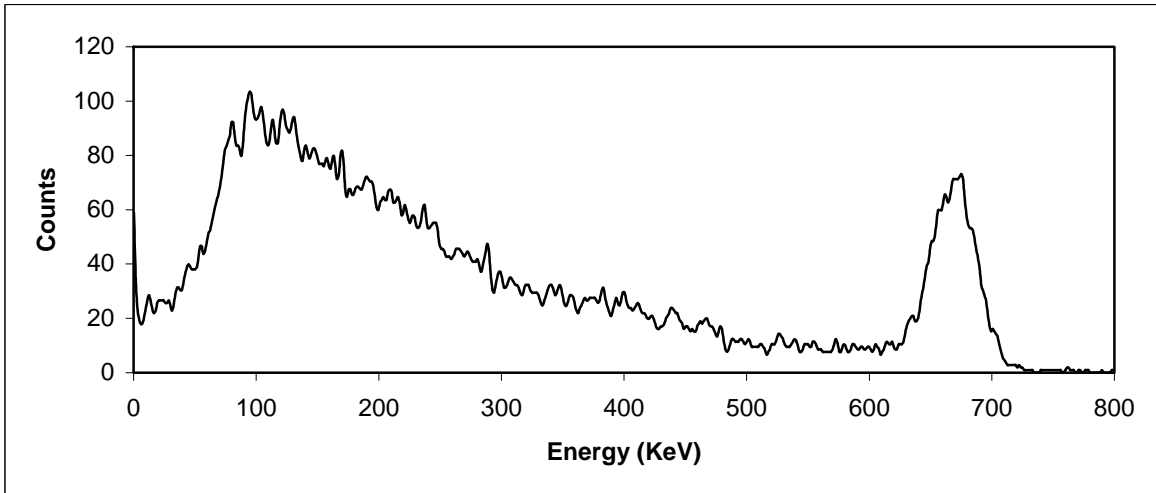

Figure (5.3): Gamma ray spectrum of ^{137}Cs source. Detector NaI(Tl) and radiation source are located on the top of the Terra Rossa calibration material in a wood box. Detector- source Distance is 20 cm.

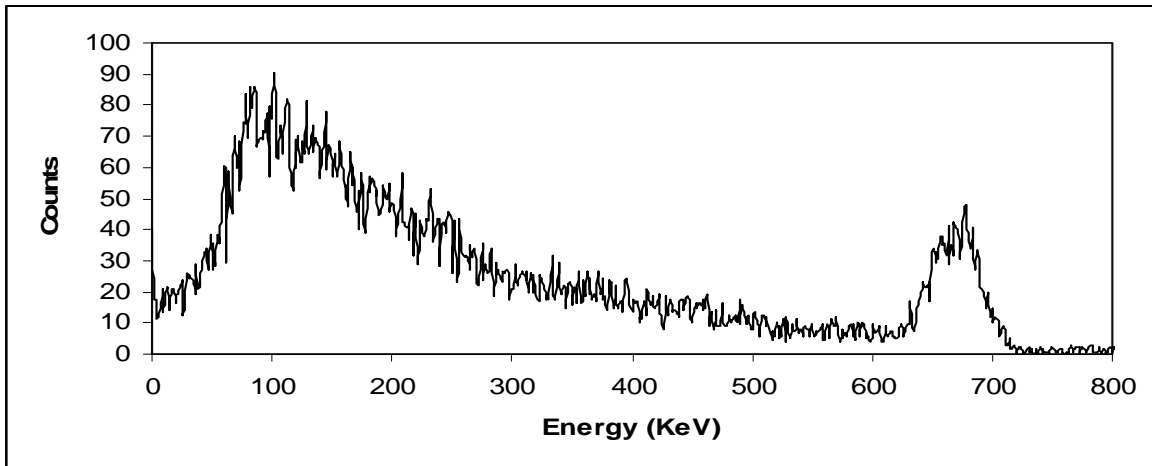

Figure (5.4): Gamma ray spectrum of ^{137}Cs source. Detector NaI(Tl) and radiation source are located on the top of the Terra Rossa calibration material in a wood box. Detector- source Distance is 25 cm.

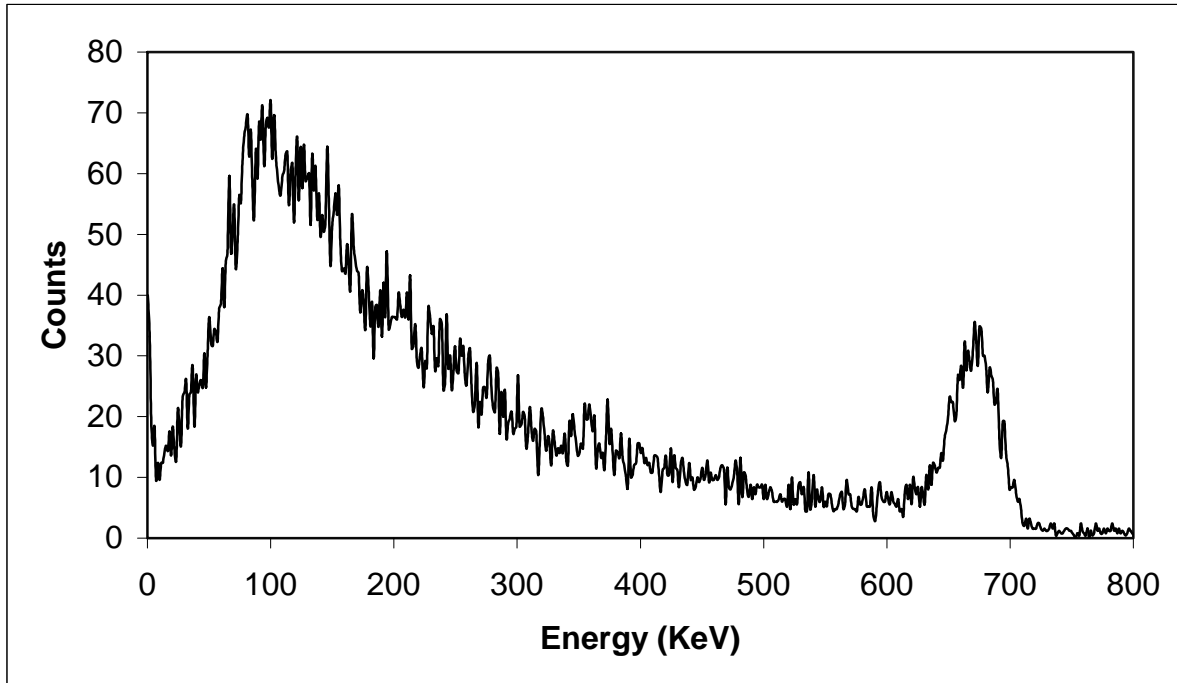

Figure (5.5): Gamma ray spectrum of ^{137}Cs source. Detector NaI(Tl) and radiation source are located on the top of the Terra Rossa calibration material in a wood box. Detector- source Distance is 30 cm.

As noticed from the five spectra of five different detector- source separation distances for Terra Rossa soil, the spectra changes with different distances, the spectra changes in all its segment but the changes more clear in the Compton backscattering peak and the photo peak. As the detector –source separation distance increase the material section under the test increased, so more atoms and more gamma ray interaction with atoms; photons that will absorbed or scatter will increase and number of photons that would reach the detector will decrease. Differences between the all spectra will be more clear in

the next graph in which all Terra Rossa gamma ray spectra are presented in Fig.(5.6).

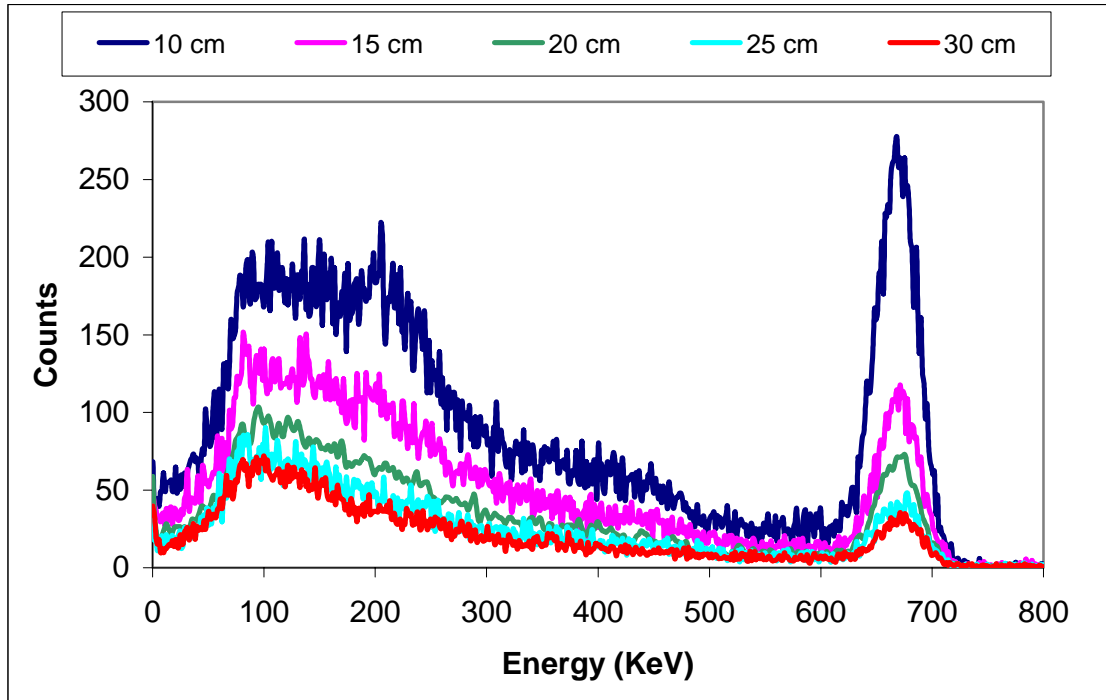

Figure (5.6): Gamma ray spectra of ^{137}Cs source. Detector NaI(Tl) and radiation source are located on the top of the Terra Rossa calibration material in a wood box. Various detector- source distances are used.

As shown in Fig.(5.6), peak of Compton backscattering (180 -480 KeV) and photo peak are the most affected margin of changing detector- source separation distance. In that's margin its easy to distinguish between the spectra's lines.

5.1.2 Gamma Ray Spectra Collected for Lime Stone (powder) :

Spectra for different detector-source separation distances are collected also for lime stone (powder) calibration box in Fig.(5.7) and for sand calibration box in Fig.(5.8).

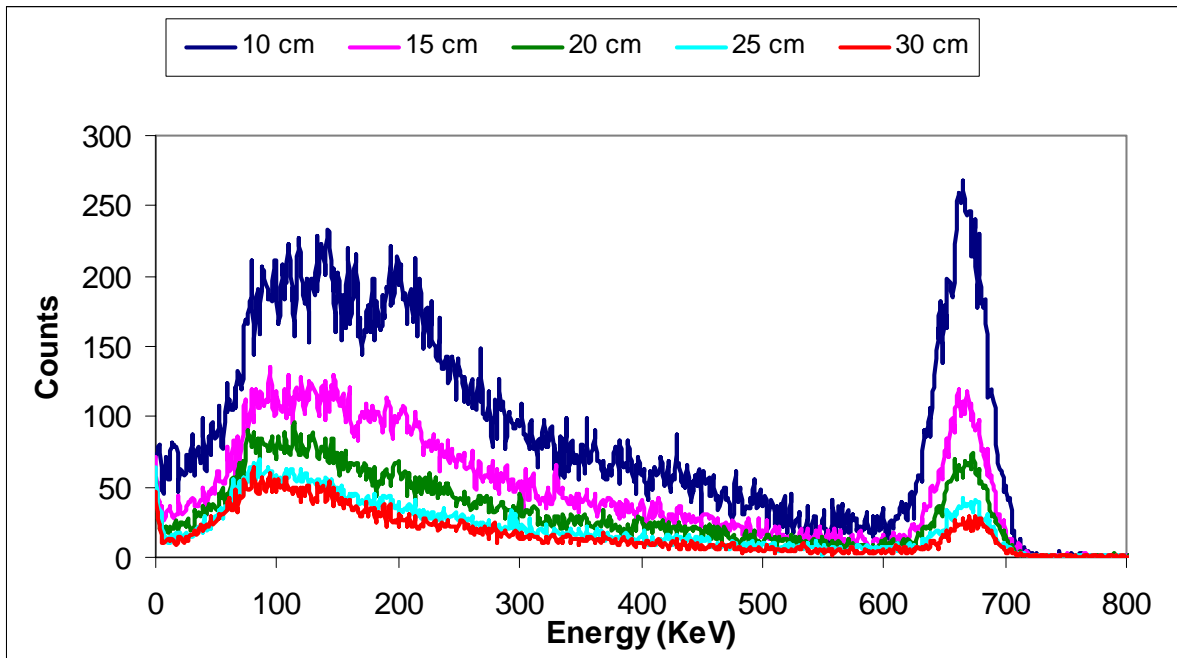

Figure (5.7): Gamma ray spectra of ^{137}Cs source. Detector NaI(Tl) and radiation source are located on the top of the lime stone (powder) calibration material in a wood box. Various detector-source distances from 10 to 30 are used.

5.1.3 Gamma Ray Spectra Collected for Sand:

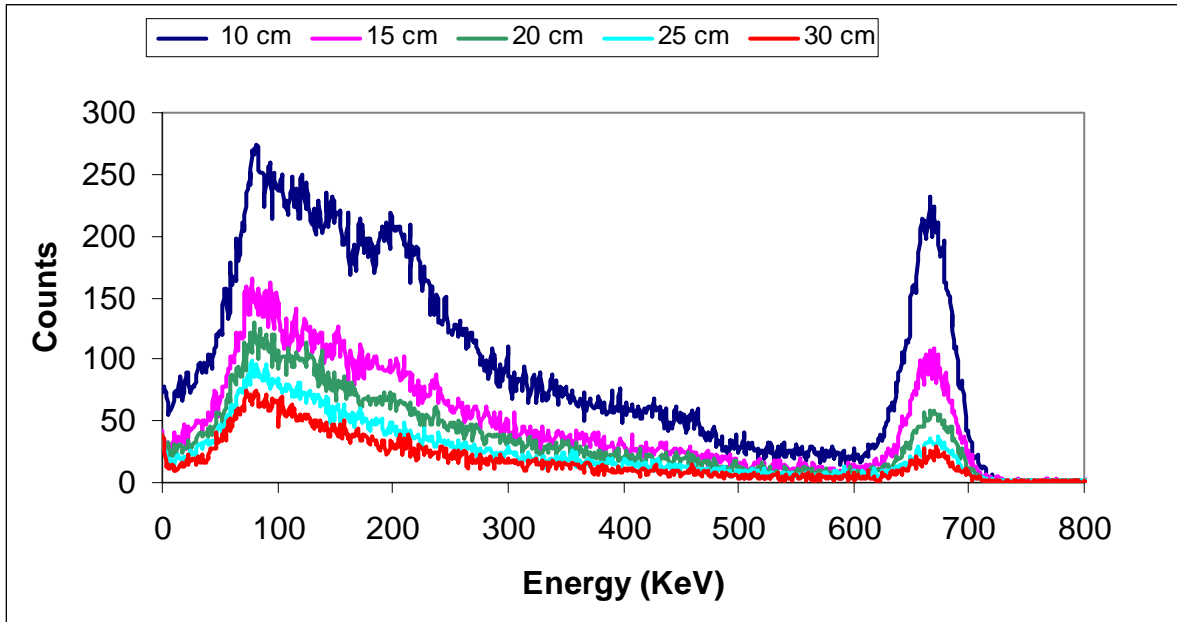

Figure (5.8): Gamma ray spectra of ^{137}Cs source. Detector NaI(Tl) and radiation source are located on the top of the sand calibration material in a wood box. Various detector- source distances from 10 to 30 are used.

From the spectra graphs, it is noticed that with the highest density used material that is the sand (1.6 g/cm^3) the differences in counts numbers between spectra are bigger than the differences between the Terra Rossa gamma ray spectra which have the lightest density of (1.3 g/cm^3). This is because of, in materials with high density, gamma ray photons will interact with more material's atoms, so less photons will reach the detector. In the material with light density, gamma ray photons will interact with fewer atoms, so less loose of photons energy and so more gamma ray photons reached the detector.

5.2 Effect of Various Soils Density on Gamma_ Ray Spectra

While gamma rays passing through material, gamma ray will interact with materials atoms even by absorption or scattering that is depending on the gamma ray energy and material density.

As the material bulk density increase the materials atoms increase, Gamma ray photons will interact with more atoms and more energy loss will occur so less Gamma ray photons will reach the detector.

Gamma ray count rate for our calibration materials affected by the material density, that will be cleared by studying the count rates for all materials in each distance in the two Gamma ray spectral ranges of interest in this work are (180 - 480 KeV) and (250 – 730 KeV).

5.2.1 Gamma Ray Count Rate in The Range of 250 -730 KeV:

This energy range is used in a lot of studies because the lower energy limit of 250 KeV is counted to avoid the gamma ray energy photons that depend on its interaction with matter on the material chemical composition. The upper limit of 730 KeV gives us a guarantee that the gamma rays of maximum energy are counted.

The relationship between the gamma ray count rate and material density is presented in the Table (5.1) below.

Table (5.1): Gamma Ray count Rate of ^{137}Cs detected for various calibration materials and various distances between the detector and the source. (Energy range of the γ – ray spectrum: 250 – 730 KeV).

Detector-source separation distance (cm)	γ - ray count rate (material density of 1.3 g/cm ³)	γ - ray count rate (material density of 1.55 g/cm ³)	γ - ray count rate (material density of 1.6 g/cm ³)
10	406	391	374
15	214	208	187
20	144	132	129
25	86	82	99
30	78	60	49

From the data in Table (5.1), we can notice that the gamma ray count rate decrease when the material bulk density increase for all different detector-source separation distances that used in this study.

In Fig.(5.10) below, a curve for each distance is found for all calibration materials bulk densities. The curves of detector-source separation distances of 10, 15 and 20 cm separated enough from each other. After detector- source separation distance of 20 cm, readings become more closed to each other.

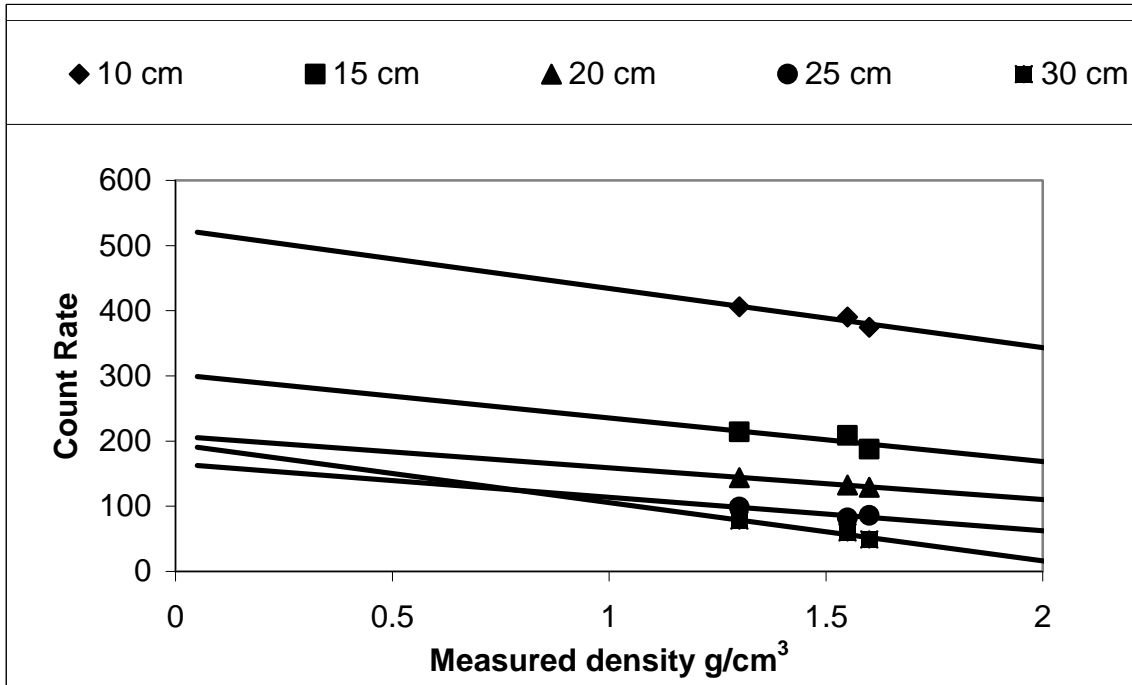

Figure (5.9): Gamma ray detected count rate as a function of different materials densities in the energy range of 250 – 730 KeV.

5.2.2 Gamma Ray Count rate from the Compton Backscattering Peak within Energy Range of 180 – 480 KeV:

The same previous relationship is investigated within energy range of the gamma ray Compton backscattering peak (180 – 480 KeV).

Gamma ray count rate gained by gamma ray backscattering spectroscopy spectra for this energy range for all materials densities in each distance are listed in Table (5.2) below.

Table (5.2): Gamma Ray count Rate of ¹³⁷Cs detected for various calibration materials and various distances between the detector and the source.(Energy range of the γ – ray spectrum: 180 – 480 KeV).

Detector-source separation distance (cm)	γ - ray count rate (material density of 1.3 g/cm ³)	γ - ray count rate (material density of 1.55 g/cm ³)	γ - ray count rate (material density of 1.6 g/cm ³)
10	345	339	354
15	203	194	177
20	134	120	129
25	87	75	95
30	67	87	75

The relationship between gamma ray count rate and the calibration material bulk density, for various source – detector distances is shown in Fig.(5.10) below.

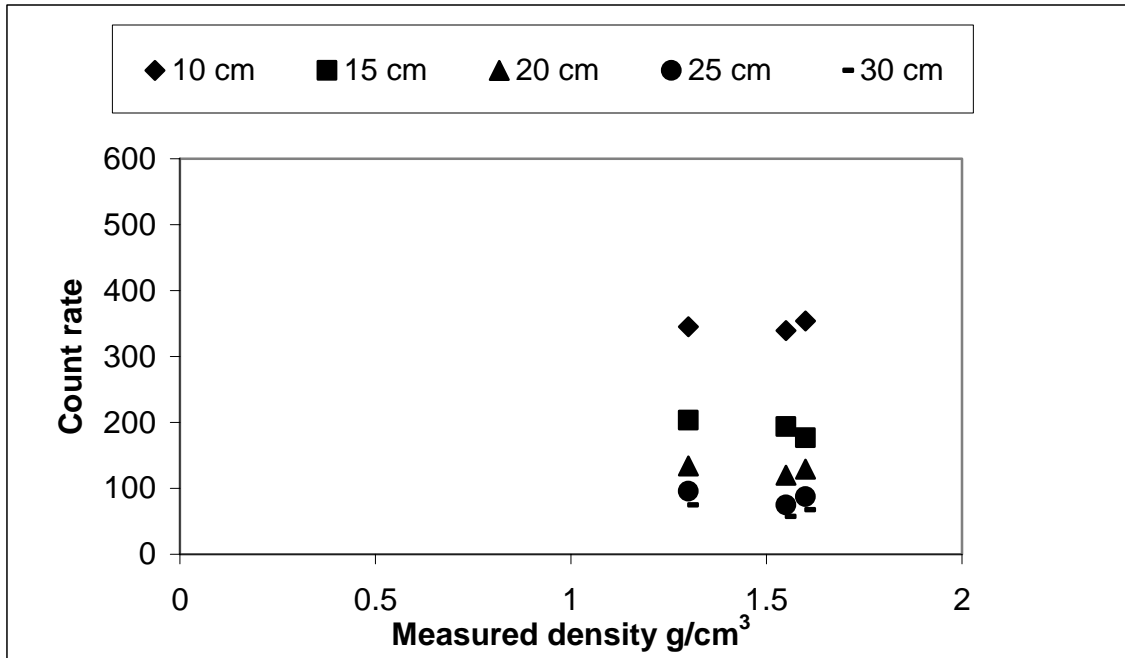

Figure(5.10): Gamma ray detected count rate as a function of different material densities in the energy range of 180 – 480 KeV.

It is noticed from Fig.(5.10) that readings of count rates from using different detector-source separation distances are closed to each other except with distance of 10 cm which make better to use the γ -ray energy range of (250-730 KeV).

5.3 Establishing the Relationship between Soil Bulk Density and Detector Response

As mentioned before, calibration process is performed to find the relationship between the gamma backscattering spectroscopy count rate and the materials bulk density.

In order to find this relationship for this study, there are four sets of data to work with to find out the best equations with the optimal detector-source separation distance. Those four sets are about two ranges of spectral gamma ray energy sections of (180- 480 KeV) and (250- 730 KeV), with using two detector-source separation distance of 10 and 20 cm.

Energy range of (180 -480) KeV is the range in which the Compton backscattering peak is found. Energy range of (250- 730) KeV is the range that includes the Compton backscattering peak, Compton edge and the photopeak which is the range that all studies of gamma ray backscattering spectroscopy used.

5.3.1 Relationship of the Material Density Vs Gamma Ray Count Rate with 10 cm Detector-Source Separation Distance:

Data of gamma ray count rate with using a detector-source separation distance of 10 cm, and the measured material's bulk density in two gamma ray spectrum range of (180- 480 keV) and (250-731 KeV) are shown below in Fig.(5.11) and Fig.(5.12) respectively.

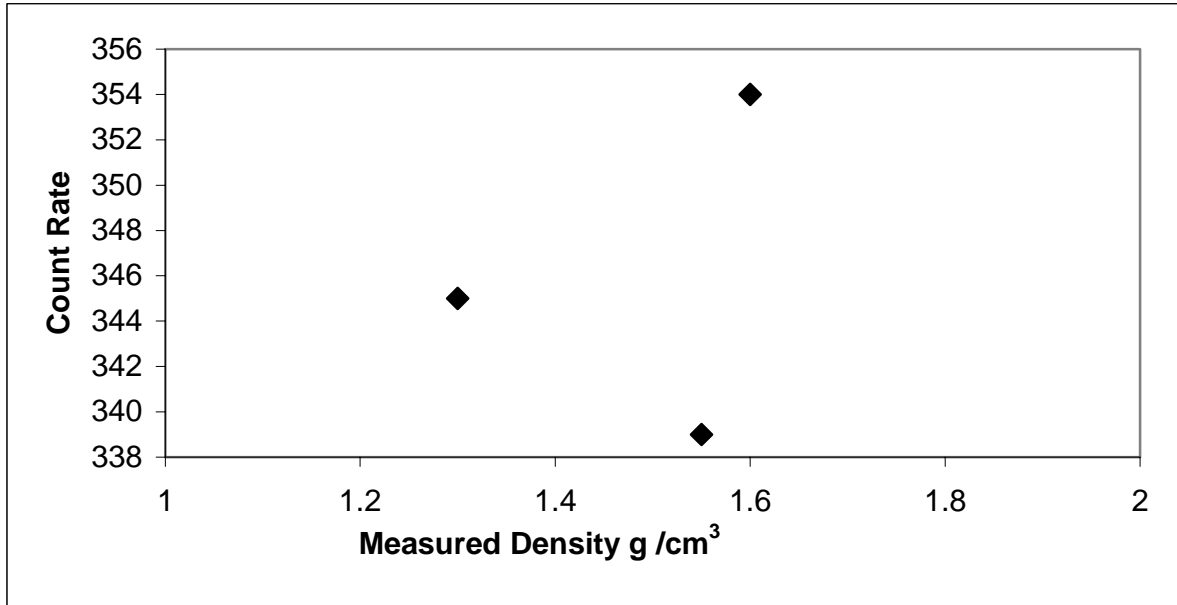

Figure (5.11): Material density Vs count rate in gamma range of (180-480 KeV), with using 10 cm as detector-source separation distance.

Data in fig.(5.11) show that, there is no relation ship that could be introduced in order to find an equation to apply in field measurements later.

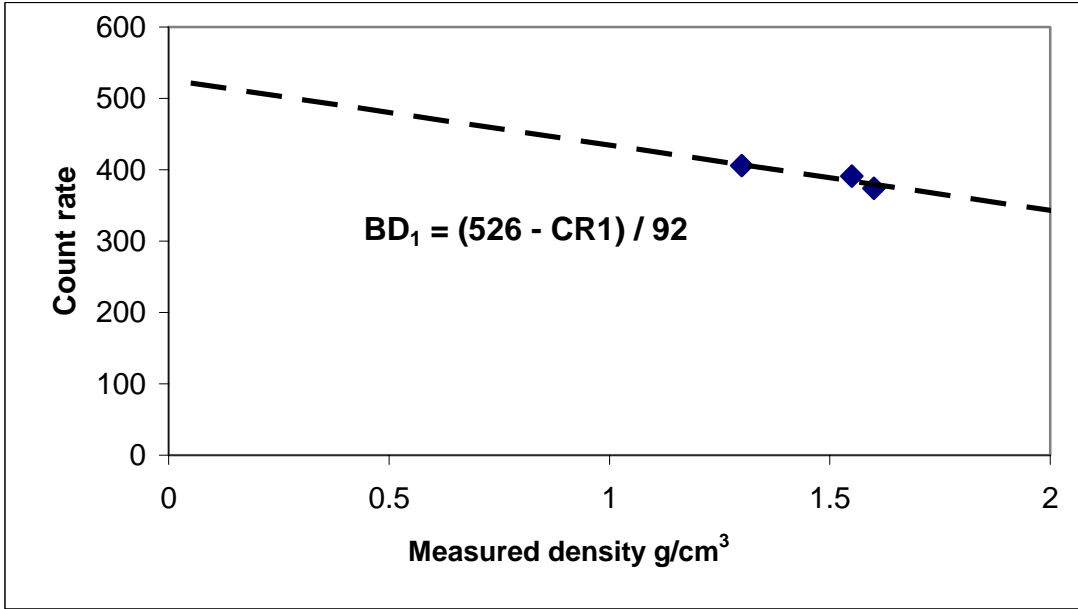

Figure (5.12): Measured bulk density Vs count rate in gamma ray range of (250-730 KeV), with using 10 cm as a detector-source separation distance.

5.3.2 Relationship of the measured density Vs gamma ray count rate with 20 cm detector-source separation distance:

Data about gamma ray count rate with using a detector-source separation distance of 20 cm and the material's bulk density in two gamma ray spectrum ranges of (180- 480 keV) and (250-730 KeV) are shown above in Fig. (5.13) and (5.14) respectively.

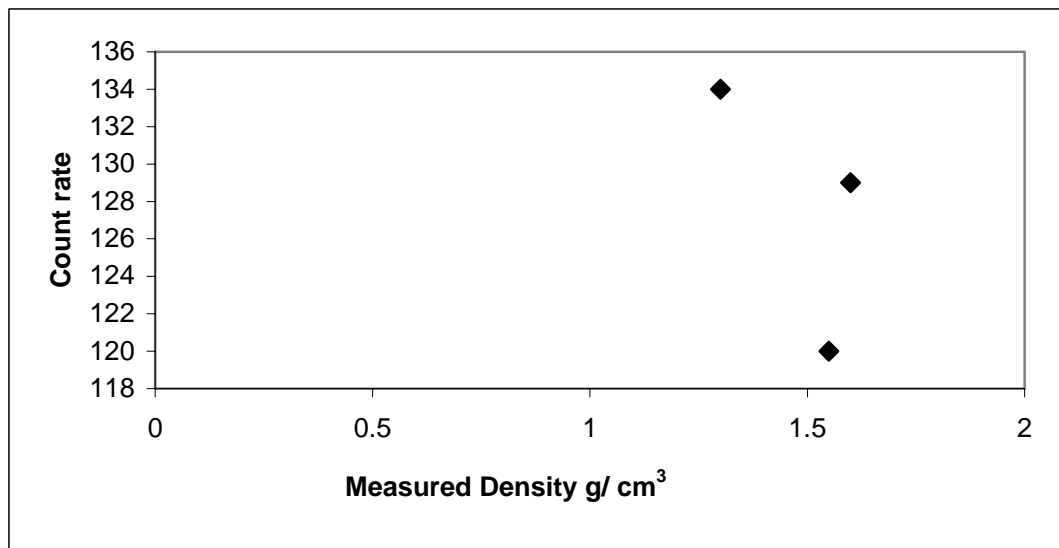

Figure (5.13): Measured bulk density Vs count rate in gamma range of (180-480 KeV), with using 20 cm as detector-source separation distance.

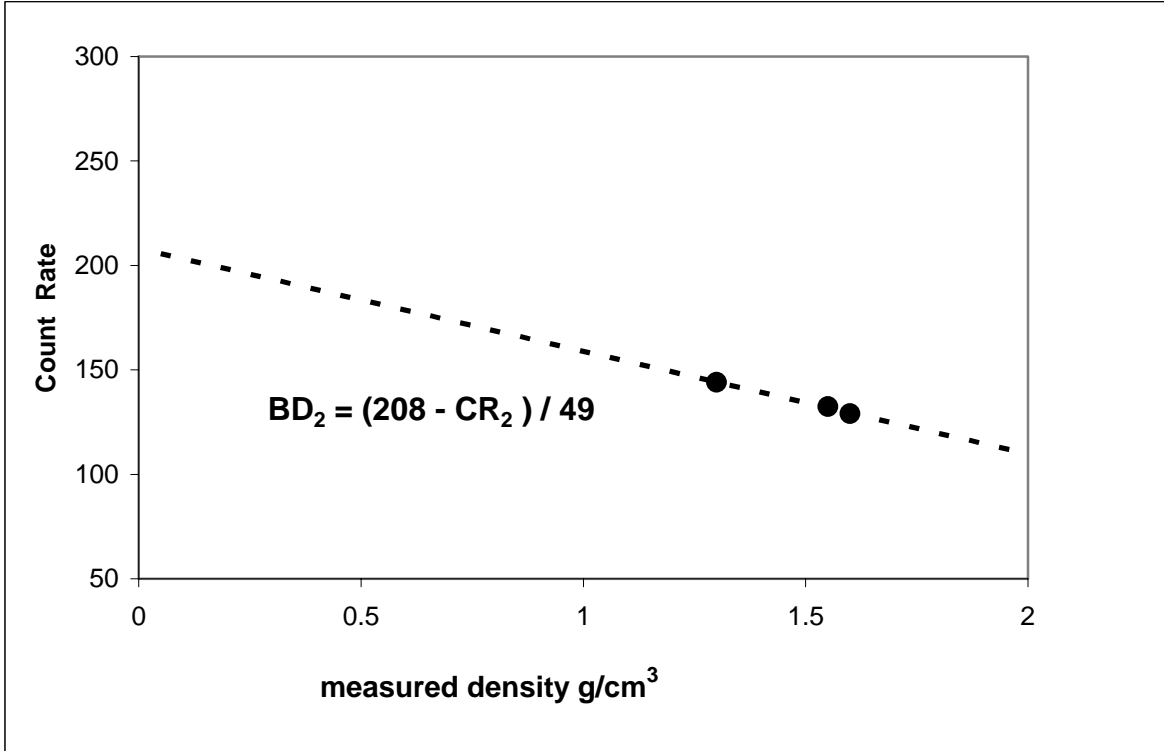

Figure (5.14): Measured bulk density Vs count rate in gamma range of (250-730 KeV), with using 20 cm as detector-source separation distance, the best fit line and its equation are included.

5.4 Field measurements

Density measurement using our detecting system is performed in open field in Beit Fajjar over a Terra Rossa land. Measurements were performed at two different detector-source separation distances of 10 cm and 20 cm. Comparisons are done between this actual field measurements and calibration measurements on terra Rossa soil material. The results obtained at 20 cm separation distances are in better agreement than at 10 cm. This probably due to the fact, which much material being tested is involved in the 20 cm distance measurements. Therefore, the optimal distance between the detector and the radiation source could be considered in this study as 20 cm, using the energy range of (250-730 KeV).

In Fig(5.15) below the spectra of Terra Rossa soil measurements in Beit Fajjar using 10 and 20 cm as a detector-source separation distance.

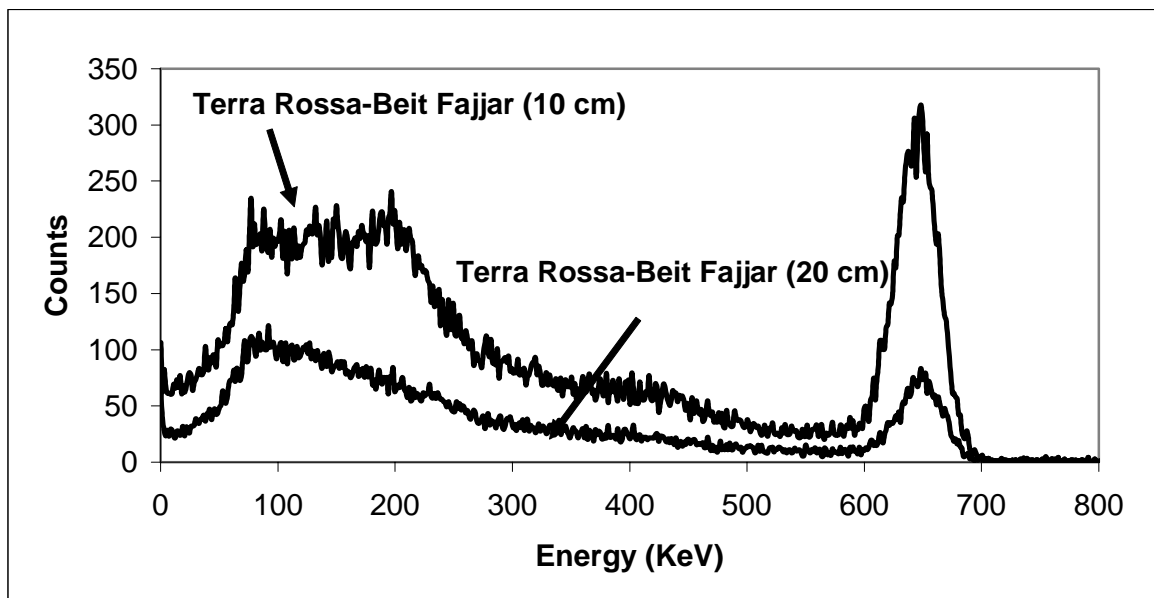

Figure (5.15): Terra Rossa soil measurements in Beit Fajjar using 10 and 20 cm as a detector-source separation distances.

The data in table (5.3) below are about the gamma ray counts rates of the Terra Rossa soil in the field of the energy range of (250- 730 KeV).

Table (5.3): Gamma Ray count Rate of ^{137}Cs detected for field measurement in Beit Fajjar over Terra Rossa soil and for two distances between the detector and the source.

Distance cm	Beit Fajjar field count rate Counts.s ⁻¹
10	430
20	141

Fig.(5.16) shows a comparison between calibration counts rates and in-situ measured counts rates.

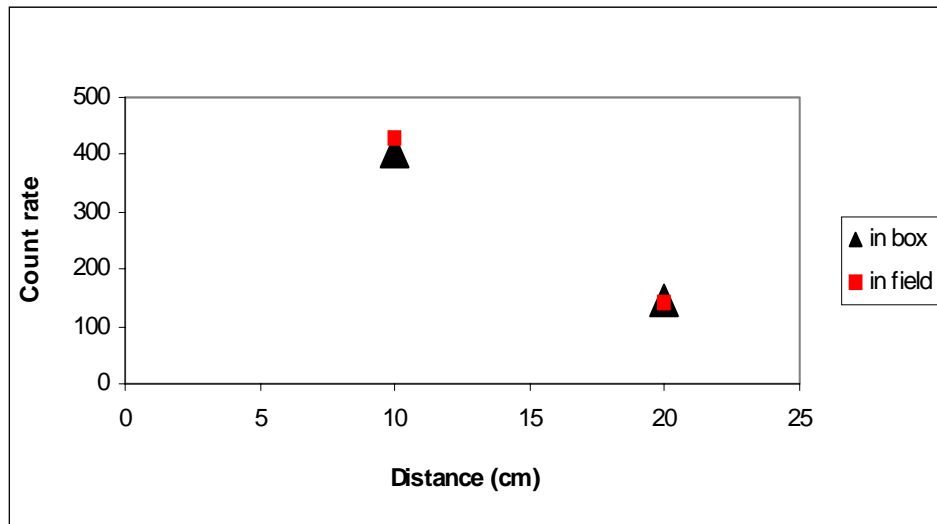

Figure (5.16): A comparison between the Count Rate of backscattered gamma ray emitted from ^{137}Cs and measured by a scintillation detector of the Terra Rossa in the calibration box and in the field, with two detector-source separation distance of 10 and 20 cm. Energy range of (250-730 KeV).

5.4.1 Using the Equations to Calculate the Terra Rossa Soil Field Bulk Density:

Equation (5.1) is the suitable equation while using a distance of 10 cm as a detector-source separation distance.

$$BD_1 = \frac{526 - CR_1}{92} \quad (\text{Eq 5.1}).$$

Where CR is the detected gamma ray count rate.

For a CR of 430

$$BD_1 = 1.04 \text{ g cm}^{-3}$$

Equation (5.2) is the suitable equation while using a distance of 20 cm as a detector-source separation distance.

$$BD_2 = \frac{208 - CR_2}{49} \quad (\text{Eq 5.2}).$$

For $CR_2 = 141$

$$BD_2 = 1.36 \text{ g cm}^{-3}.$$

The difference between the true density of the Terra Rossa (used in calibration) and evaluated field value does not exceed 6 % using a separation distance of 20 cm.

Comparing the two results, its evident that 20 cm of detector-source separation distance, using the energy range of 250-730 KeV, provide very good results.

5.4.2 Measurements of soil density at Al-Quds University site

Measurements of soil density were performed at five different locations at main campus-Al Quds University- Abu Dies.

Locations were selected randomly and gamma ray spectra were collected for 3 minutes for each location with a detector – source optimal configuration (the distance between the detector and the ^{137}Cs is 20 cm). The spectra energy range of 250-730 KeV is considered. Results are been summarized in Table (5.4).

Table (5.4): Results of bulk density measurements at Al-Quds University site.
 Detector-source distance is 20 cm. Time of measurement is 3
 minutes.

Location	Count rate (counts /seconds)	Evaluated bulk density g/cm ³
1	116	1.9
2	143	1.3
3	152	1.14
4	125	1.7
5	165	0.9

- Location 1 is with a dry soil, far from the irrigation of that area with smooth surface, no rocks near that area.
- Location 2 is a dry soil with smooth surface but it is much nearer to the agricultural area of that site.
- Location 3 is near The Arab Institution, far about 1 meter from a big tree.
- Location 4 is far from trees, but the surface of that area is unsmoothed enough, much of big rock found there.
- Location 5 is near the Higher Education College, the area surface is smooth and free from grass, but it is surrounded by a highly agricultural area.

5.6 Rain effect on soil bulk density

There are many factors affect soil density such as presence of organic material, soil depth, soil compaction and soil moisture.

Soil moisture has a strong affect on its density. Since the soil composition, volume and conditions is remaining the same, so the only thing which could alter the density, is the changing in its moisture.

Measurements are conducted on the two types of soil in Al-Quds University main campus in Abu-Dies to measure the differences between the count rate in the dry soil and in the wet soil.

Al-Quds University field measurements are performed in two locations, one of Terra Rossa soil and another with chalk to detect the gamma ray backscattering spectroscopy count rate differences with increasing soil moisture.

The effect of the rain (moisture) will be more clear when comparing the gamma ray count rate detected for the same location before the rain and after the rain.

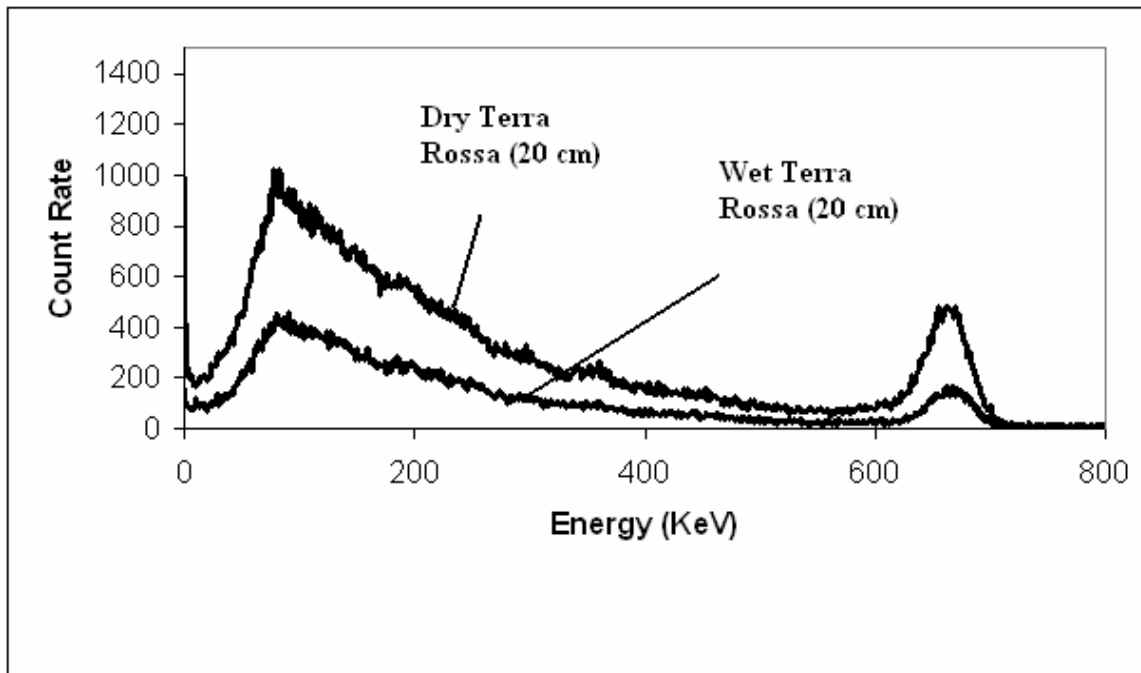

Figure(5.17): A comparison between the gamma ray backscattered count rate spectra of same type of soil in Al-Quds University in dry and wet case.

From the Fig.(5.17) the dry spectrum is highest than the wet spectrum. Because with increasing the density of the soil by increasing its moisture the gamma ray photons that will be absorbed in the soil is more than in the dry state.

In the university, the counts were high in the dry case in comparison with the wet case as following:

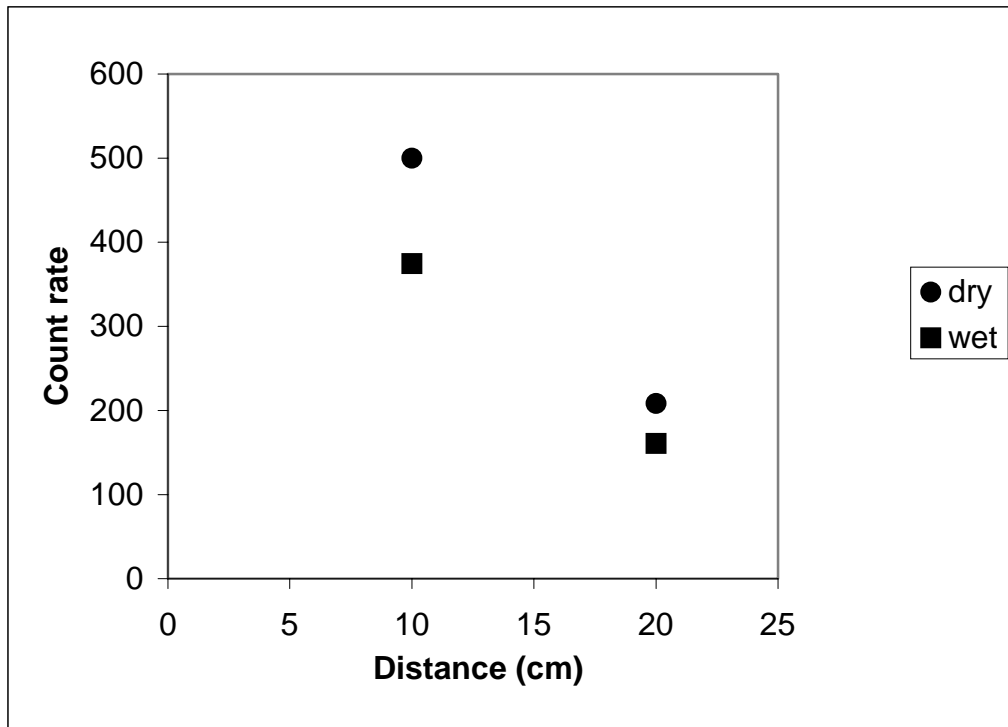

Figure (5.18): The Count Rate in dry and wet case with using 10 and 20 cm as detector-source separation distance.

For another type of soil:

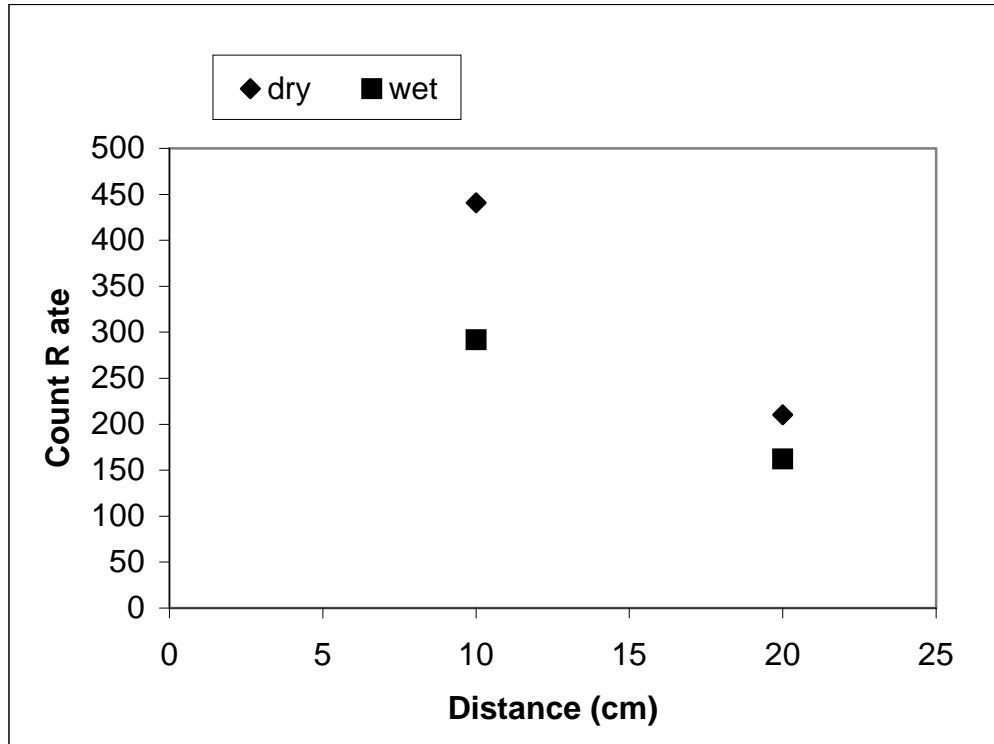

Figure (5.19): The Count Rate of another type of soil in dry and wet case with using 10 and 20 cm as detector-source separation distance.

5.7 Conclusion and Recommendation

The importance of this study stems from the following: first, it is the first study of its type in Palestine; and it has established a new method for determining soil bulk density by using one of the nuclear techniques.

The system used for measurements provided very good results. It is well calibrated, easily handled. It is capable of producing soil bulk density evaluations in few minutes.

The introduced system in this work can also be applied in other applications mainly in road constructions.

Recommendations can be summarized as follows:

1. Continuing studies about this system to make it more accurate, and to improve its performance.
2. Increase the number of measurement sites. Build up a map for soil bulk density in all area over Palestine.
3. To make special calibration blocks with standard characteristics, making from metal to avoid leakage and changing in its density, which makes it easy to repeat the calibration process to more field measurements.
4. Establish a laboratory for gamma ray spectroscopy to be able to analyze soil samples in different locations.
5. To form a complete team consists of Gamma Ray Backscattering Spectroscopy specialists and soil scientists in order to perform a complete valuable work.

References

- InstroTek, Inc.,(1999). Understanding and Operating Nuclear Gauges More Effectively
- Ciftcioglu, O., Taylor, D., (1970). A Gamma – Backscatter Density gauge with Differential- Mode Counting. Department of electronic Science, University of strathdydl, Scotland.
- Department of Main Roads, The State of Queensland., (2003). Nuclear Gauge Testing Manual, section 1 and section 2.
- Thomas, B., Randrup and John M. Lichter.,(2001). Measuring Soil Compaction on Construction Sites: A review of Surface Nuclear Gauge And Penetometers. Journal of Arboriculture 27(3): May 2001.
- Ball, A., (1997), Measuring Physical Properties at the Surface of a Comet Nucleus.U.K, University of kent.
- Zha, J., (2000). Revision of California Test Method 111, California Department of Transportation Sacramento, CA 95819.
- Cruvinel, P., Balogun, F., (1999). Compton Scattering Tomography for Agricultural Measurements.

- C.A Kalfas, Tsoulou, E., (2002). Simulate Program: A Gamma Ray Spectroscopy Tool.
- André, C., (1998). Soil Dry Bulk Density.
- Harmon, N., (2003). The Compton Effect.
- Uyttenhove, J., (1995). Capabilities and Limitations of High Resolution Gamma Spectroscopy in Environmental research. Krijgstan, Ghent University, Radiation Physics Laboratory 281(5-12), B-9000 Gent, Belgium.
- Nilson, G., Reilly, D., Gamma Ray Interaction with Matter.
<http://www.fas.org/sgp/othergov/doe/lanl/lib-www/la-pubs/00326397.pdf>.
(accessed 28/2/2007).
- Taylor, D., Kansara, M., (1967). Improvements in the Method of Measuring the Density of Soil Using Nuclear Back-scatter.
- Jansson, K., (1999). Comparison of Density and Water content Determinations Using Soil Cores and A Dual Probe Density Gauge. Sweden, Uppsala, Swedish University of Agricultural Sciences.
- Troxler Electronic Laboratories, (1998). Application Brief, Model 3440 Road ReaderTM , Nuclear Density Gauge.

- United State Patent, (1986). Method for Recalibrating Nuclear Density Gauges., Inventor: Ali Regimand., John L. Molbert. Patent number 4,587,623.
- Steele, Jacqueline G.; Koger, Jerry L.; Trowse, Albert C., Jr.; Sirois, Donald L., (1983). Core Versus Nuclear Gauge Methods of determining Soil Bulk Density and moisture Content.
- Canberra Inc., (2000). Genie Basic Spectroscopy Software, V. 3.0, Meriden, CT 06450, U.S.A. ([www. Canberra.com](http://www.Canberra.com)).
- Al-Masri, H., (2006). Study of Environmental radioactivity in Jerusalem and Bethlehem by in-situ Gamma ray Spectroscopy, Al-Quds University, Palestine, Jerusalem.
- Peterson, R., Hornack, Th., Morian, D., (1986). Apparatus and Method for Measuring Bulk Density of Solid Particles.
- Regimand, A., (1997). Validation and calibration apparatus and method for nuclear density gauges. Patent number 5,923,726.

قياس الكثافة الظاهرية للتربة باستخدام مطيافية أشعة جاما

ملخص

تناقش هذه الدراسة طريقة لقياس كثافة المواد الظاهرية بواسطة استخدام تقنية نووية. و لتحقيق هذا استخدمت تقنية مطيافية أشعة جاما الحقلية.

يتكون نظام القياس من مكشاف اشعاع و ميسي (بلورة يوديد الصوديوم المطعم بعنصر الثاليوم) بحجم 3×3 " انش متصل مع محلل طيف من نوع Inspector 2000 من شركة كانبيرا و ذلك مع جهاز كمبيوتر محمول. استخدم عنصر ^{137}Cs بطاقة (662 KeV) كمصدر لأشعة جاما ، كما استخدمت أنواع مختلفة من التربة بكثافات ظاهرية مختلفة لاجراء عملية المعايرة.

قبل تطبيق هذه التقنية في الحقل أجريت عملية المعايرة لايجاد علاقة مناسبة بين كثافة المادة الظاهرية و طيف جاما الذي تم جمعه (قياسه). تمت عملية المعايرة باستخدام ثلاثة مواد مختلفة ذات ثلاثة كثافات مختلفة معبأة بداخل صناديق خشبية بأبعاد $59 \times 42 \times 34$ سم صنعت مخصصة لهذا الغرض. يغطي مصدر اشعاع جاما (^{137}Cs) بدرع من الرصاص لمنع مرور أشعة جاما بشكل مباشر نحو المكشاف . ثم يوضع كل من مصدر أشعاع جاما و المكشاف فوق سطح المادة المراد قياسها لتبدأ عملية القياس لوقت قصير(60)ثانية. حتى يتم تفادي قياس شعاع جاما الطبيعي في بيئة القياس و تفادي ارتفاع درجة حرارة الاجهزة الذي يؤدي الى احداث فروقات في القراءات.

تعالج أطياف جاما التي تم جمعها و قياسها باستخدام نظام Genie 2000 . يحسب معدل اشعاع جاما (Count Rate) لكل عملية قياس على حده. ثم يوضع منحنى المعايرة الذي يوضح العلاقة بين كثافة المادة و معدل اشعاع جاما الذي تمت معالجته مما يسهل ايجاد علاقة رياضية مناسبة بين كثافة المادة و معدل اشعاع جاما.

تمت عملية القياس في الحقل حتى يتم التأكد من مدى دقة عملية المعايرة. النتائج الخاصة بتربة Terra Rossa كانت متوافقة جدا مع النتائج التي تم قياسها من قبل.

تم القيام بقياسات الحقل بعد انتهاء عملية المعايرة مستخدمين العلاقة الناتجة عن عملية المعايرة، حيث كان معدل العد في عملية المعايرة Terra Rossa وباستخدام مسافة 10 سم و هي المسافة الفاصلة بين المكشاف و مصدر اشعاع جاما ($406 \text{ counts.s}^{-1}$) ، و كان القياس في الحقل و على نفس المسافة ($430 \text{ counts.s}^{-1}$) ، اما باستخدام مسافة 20 سم كان القياس في عملية المعايرة ($144 \text{ counts.s}^{-1}$) اما في الحق ($141 \text{ counts.s}^{-1}$)، و نلاحظ تقارب النتائج، و هذا في مجال الطاقة الذي يمثل الجزء (KeV 730 - 250) من طيف أشعة جاما. و قد أجريت قياسات ميدانية في خمسة مواقع مختلفة في الحرم الرئيسي في جامعة القدس. و تشير نتائج تقدير الكثافة الظاهرية في المناطق الخمسة المختلفة الى نتائج منطقية تتناسب و نوعية التربة و المواد المتواجدة في مواقع القياس.

كما ان عملية القياس قد اجريت ايضا بهدف قياس تأثير مياه الامطار على قياس كثافة التربة.

