

**Deanship of Graduation Studies**  
**Al-Quds University**

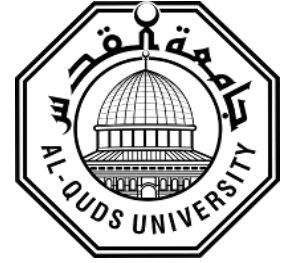

**Online Remotely Failure Detection for Vehicle  
Components**

**Tujan Hisham Abu-Tammam**

**M.Sc. Thesis**

**Jerusalem – Palestine**

**1439–2017**

# **Online Remotely Failure Detection for Vehicle Components**

**Prepared By:  
Tujan Hisham Abu-Tammam**

**B.Sc. :Mechatronics Engineering, Palestine  
Technical University-PTUK, Palestine**

**Supervisor: Dr. Imad Al-Zeer**

**Athesis submitted in partial fulfillment of the requirements  
for the degree of Master of Electronic and Computer  
Engineering/Department of Electronic and Computer  
Engineering/ Faculty of Engineering- Al-Quds University**

**1439-2017**

Al-Quds University

Deanship of Graduate Studies

Master of Electronic and Computer Engineering

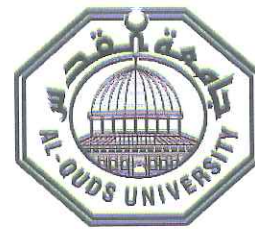

**Thesis Approval**

**Online Remotely Failure Detection for Vehicle Components**

Prepared By: TujanHishamAbu-Tammam

Registration No.: 21511835

Supervisor: Dr. Imad Al-Zeer

Master thesis submitted and accepted, Date: 16/12/2017

The names and signatures of the examining committee members are as follows:

1- Head of Committee

Dr.Imad Al-ZeerSignature: .....

2 -Internal Examiner

Dr. Ahmad QutobSignature : .....

3 -External Examiner

Dr.Yousef AwwadSignature: .....

**Jerusalem – Palestine**

**1439–2017**

### **Declaration**

I Certify that this thesis submitted for the Degree of Master is the result of my own research, except where otherwise acknowledged, and that this thesis (or any part of the same) has not been submitted for a higher degree to any other university or institution.

Signed by: .....

**Tujan Hisham Abu-Tammam**

**Date:16, December, 2017**

## **Dedication**

I dedicate this work to my parents who always supported me.

**TujanHisham Abu-Tammam**

## **Acknowledgement**

As I am writing the last words of this thesis, I greatly appreciate the thesis supervisor Dr. Imad Al-Zeer for his support and time he spent with me in order to make this thesis a successful one.

I would like to thank the thesis examiner Dr. Yousef Awwad and Dr. Ahmad Qutob for their valuable suggestions and corrections on this work, which greatly helped me to improve it in various aspects. Special Thanks for my friend Noor Obead for the support she gave me to accomplish this achievement.

Last but not least, most profound gratitude and respect to my family, especially my beloved parents Hisham Abu Tammam and Basima Abu Tammam, and my family who are the ultimate source of my motivation to work hard and they are also the inspiration of my life. Therefore, I proudly dedicate this work to all of them. And may Allah SWT bless all of them.

## **Abstract**

With the rapid evolution of wireless communication technologies, it is possible to prepare a new kind of services where interested in monitoring vehicles remotely, by taking the advantage of electronic systems in vehicles. This service could prevent breakdowns by detecting vehicle problems at an early stage.

This research aims to improve the performance of the remote diagnostic system and monitoring vehicles. Our system consists of an On-Board Diagnostics (OBD) port, OBD Bluetooth adapter interface, Android application on a smartphone, web server and three different web pages. The application collects data when a detection of an error from the ECU occurs. The OBD port connected the ECU with the OBD Bluetooth adapter interface. The mobile application is capable to transmit data to the web server using (WI-FI/2.5G/3G) connection, and store it in the database. The results could be viewed by the relevant authorities that can access the web page to monitor the vehicle technical conditions. This system was tested through several experiments on several numbers of sample vehicles. When it detects the error in the vehicle the data transmit using an OBD-II Bluetooth to smartphone and then send it to the web server using 3G/4G/Wi-Fi connection.

Data collected includes both DTC codes for error, and real-time vehicle data when error appear on the vehicle. All data is presented in three web pages, the first web page for maintenance center, according to an entry vehicle VIN number displays all information at the time when DTC error appeared in the vehicle, the second webpage for an insurance company by entry the owner ID

number displayed the details about the vehicle when an error appeared, and third web page for the vehicle owner, when registered for his/her page, basic information such as name, mobile number, e-mail address, and ID number must be entered. And also, the server send an e-mail message to the user, to notify if an error appeared in the vehicle to check the web page which is made by the system online.

Results show that the system is useful and can be used in real life, prove the feasibility of collecting data using a remote system, visualizing the information in real-time



## TABLE OF CONTENTS

<b>DECLARATION</b> .....	<b>I</b>
<b>DEDICATION</b> .....	<b>II</b>
<b>ACKNOWLEDGEMENT</b> .....	<b>III</b>
<b>ABSTRACT</b> .....	<b>IV</b>
<b>LIST OF FIGURES</b> .....	<b>IX</b>
<b>LIST OF TABLES</b> .....	<b>XI</b>
<b>LIST OF ACRONYMS</b> .....	<b>XII</b>
<b>CHAPTER 1</b> .....	<b>1</b>
<b>INTRODUCTION</b> .....	<b>1</b>
1.1    MOTIVATION.....	1
1.2    PROBLEM STATEMENT.....	2
1.3    THESIS GOALS .....	3
1.4    THESIS CONTRIBUTION .....	3
1.5    THESIS ORGANIZATION.....	4
<b>CHAPTER 2:</b> .....	<b>6</b>
<b>LITERATURE REVIEW</b> .....	<b>6</b>
2.1    VEHICLE ELECTRONICS.....	6
2.2    ELECTRONIC COMPONENTS.....	7
2.2.1    Sensor .....	8
2.2.1.1 Automotive Sensors Technologies .....	9
2.2.2    Electronic Control Unit – ECU .....	11
2.2.3    Actuators.....	12
2.2.3.1    Types of Automotive Actuators .....	12
2.3    AUTOMOTIVE DATA BUSES.....	13
2.3.1    CAN (Controller Area Network) .....	14
2.3.1.1    CAN Message .....	15
2.3.1.2    CAN MessageFrame .....	15
2.3.2    LIN (Local Interconnect Network).....	16
2.3.3    Flex Ray .....	16
2.4    DIAGNOSTICS .....	17
2.4.1    On-Board Diagnostic system (OBD).....	17
2.4.2    The OBD-II specification and protocols .....	19
2.4.2.1    Type of OBD2 protocols .....	20
2.4.3    ELM electronic .....	22
2.4.3.1    Type of ELM327 interfaces .....	22

2.4.4	Data Analysis.....	23
2.4.4.1	Real-time information parameter .....	23
2.4.4.2	Trouble Codes .....	24
2.5	COMMUNICATION METHODS.....	25
2.5.1	Bluetooth .....	25
2.5.2	2.5G/3G/Wi-Fi.....	26
2.6	RELATED WORK.....	27
2.7	STATE OF THE ART FOR ANDROID APPLICATION.....	30
<b>CHAPTER 3.....</b>		<b>31</b>
<b>METHODOLOGY .....</b>		<b>31</b>
3.1	ARCHITECTURE FOR THE SYSTEM.....	31
3.1.1	Topology of prototype .....	31
3.1.2	System Flowchart.....	32
<b>CHAPTER 4.....</b>		<b>34</b>
<b>SOFTWARE MODULE.....</b>		<b>34</b>
4.1	VEHICLE OWNER ANDROID APPLICATION SOFTWARE .....	34
4.1.1	Android OBD-II Reader .....	34
4.1.1.1	Real-time Parameters .....	36
4.1.1.2	Android application on Flowchart.....	37
4.2	VEHICLE OWNER REMOTE SERVER.....	38
4.2.1	Web Server .....	38
4.2.2	Data transmission tothe server.....	39
4.2.2.1	JSON(JavaScript Object Notation) .....	39
4.2.3	Database.....	41
4.2.4	Web interface.....	43
<b>CHAPTER 5.....</b>		<b>44</b>
<b>MODEL TESTING AND RESULTS.....</b>		<b>44</b>
5.1	TESTING .....	44
5.1.1	Hardware Testing .....	44
5.1.1.1	Vehicles sample .....	44
5.1.1.2	Hardware interface.....	44
5.1.2	Software Testing.....	45
5.1.3	WEB Pages .....	45
5.1.3.1	Vehicle owner page.....	46
5.1.3.2	Maintenance center .....	47
5.1.3.3	Insurance Page.....	49
5.2	RESULTS.....	50

5.2.1	Obtained data .....	53
5.2.1.1	Data size .....	53
5.2.1.2	Performance .....	53
5.2.1.3	Security issues .....	54
5.3	EVALUATION .....	54
5.3.1	Limitation .....	54
5.3.2	Features of the model .....	55
5.4	DISCUSSION .....	56
<b>CHAPTER 6 .....</b>		<b>58</b>
<b>CONCLUSION AND FUTURE WORK .....</b>		<b>58</b>
6.1	CONCLUSION .....	58
6.2	FUTURE WORK .....	59
<b>REFERENCES .....</b>		<b>60</b>
	Appendix A .....	64
	<b>الملخص .....</b>	<b>65</b>

# List of Figures

<b>List of figures</b>	<b>Page No</b>
Figure 1.1: The proposed system.	4
Figure 2.1: Basic function of an electronic system is to sense, compute & actuate.	8
Figure 2.2: Types of Automotive Sensors.	9
Figure 2.3: Type of data bus.	14
Figure 2.4: The structure of a standard CAN data frame.	15
Figure 2.5: Pin layout for the DLC.	19
Figure 2.6: ELM327 Bluetooth, USB, and Wi-Fi adaptors.	23
Figure 2.7: Definition of OBD-II Diagnostic Trouble Code.	24
Figure 2.8: Configuration of the proposed vehicle diagnostic system.	28
Figure 2.9: Configuration of the remote on-line diagnostic system.	29
Figure 3.1: Topology of prototype architecture system.	32
Figure 3.2: System flowchart.	32
Figure 4.1: Configuration of the mobile application.	35
Figure 4.2: Flowchart to work application.	37
Figure 4.3: JSON document of vehicular data.	40
Figure 4.4: Vehicles table structure in the database.	42
Figure 4.5: User table structure in the database.	42
Figure 4.6: Role table structure in the database.	43
Figure 4.7: The type of role name.	43
Figure 5.1: Screenshots of the main page.	45

Figure 5.2: Screenshots for logger new user page.	46
Figure 5.3: Vehicle owner page (user account).	47
Figure 5.4: Vehicle VIN search screen.	47
Figure 5.5: Vehicle information.	48
Figure 5.6: Maintenance center page.	49
Figure 5.7: Owner ID number searching.	49
Figure 5.8: Data page for ininsurance companies.	50
Figure 5.9: Screenshot of the email message has been sent to the user when error found.	51
Figure 5.10: Vehicle owner page.	52
Figure 5.11: Screenshot of mobile application when error found	52

## List of Tables

Table 2.1: Pin layout for OBD2 port.	19
Table 2.2: Commonly available DTCs.	25
Table 2.3: Literature review of Android application.	30
Table 4.1: List of all parameters.	36
Table 5.1: Test vehicles table.	53

## List of Acronyms

CAN	Controller Area Network
ECU	Electrical Control Unit
OBD	On-board Diagnostics
DTC	Diagnostic Trouble Codes
EECU	Engine Electronic Control Unit
TECU	Transmission Electronic Control Unit
VECU	Vehicle Electronic Control Unit
LIN	Local Interconnect Network
TDMA	Time Division Multiple Access
CARB	California Air Resources Board
USB	Universal Serial Bus
ISO	International Organization for Standardization
SAE	Society of Automotive Engineers
PWM	Pulse Width Modulation
VPW	Variable Pulse Width
KPW2000	KeyWord Protocol 2000
ELM	Electronics Microcontroller
RS232	Recommended Standard-232 ports
PID	Parameter ID
VIN	Vehicle Identification Number
Wi-Fi	Wireless Internet
2.5G	Two-and-a-half Generation
GPRS	General Packet Radio Services
GSM	Global System for Mobile
UMTS	Universal Mobile Telecommunication Service
3G	Third Generation
SIM	Subscriber Identity Module
MIL	Malfunction Indicator Light
APK	Android Application Package
IDE	Integrated Development Environment
API	Application Programming Interface
GUI	Graphical user interface
AFR	Air-Fuel Ratio
RPM	Revolutions Per Minute
Mph	Miles Per Hour
GPS	Global Positioning System

PHP	Hypertext Preprocessor
HTTP	Hyper-Text Transfer Protocol
TCP	Transmission Control Protocol
UDP	User Datagram Protocol
SQL	Structured Query Language
XML	Extensible Markup Language
JSON	JavaScript Object Notation
ID number	Identification number



# Chapter 1

---

## Introduction

The aim of this chapter is to give an idea about the purpose of this system, this chapter consists of motivation, statement of the problem that we want to solve it, the goals of the solution, and contribution to give a description for each stage.

### 1.1 Motivation

The basic architecture in cars was formed by Electrical Control Units (ECUs) for dedicated tasks together with their sensors and actuators. Today a modern car has many built in computer systems which include more than 75 independent computers, (ECU) such as fuel injections, airbags, brakes and other. All of these systems are controlled by one of several sub-electronic systems. The software code which runs on the ECUs in a modern car consists of millions of lines and over 80 % of the innovations in automotive are software based [1].

As the complexity of the software in cars grows, a way of optimizing the electrical wiring is necessitated. The solution to be adopted was bus systems, e.g. the Controller Area Network (CAN) protocol, which today is the most common in the automotive industry. This eased the possibility to extract diagnostic data and change parameters in vehicles, which make it possible for the ECUs of the vehicles to share sensor data [2].

To provide the longer existence of the vehicle, regular maintenance and monitoring are required. It is important to separate between basic and advanced diagnostics; basic diagnostics intend the process of reading error codes and check the system when the vehicle crashes, advanced diagnostics is close to remote diagnosis by using advanced diagnostics remotely, it is possible to send diagnosis commands and DTC error as a script, over the rapid communication link through vehicle to server in computer and store it in a database. The concept described above is referred to the remote diagnostics system.

There is also a computer system called On-Board Diagnostics (OBD) that can get the data from the ECU. When the OBD system detects a malfunction, an OBD scanning tool is used to get the DTC from the ECU quickly and accurately. With the prompts of DTC that shortens the service time largely. Moreover, currently the number of items in the real-time driving status that OBD can monitor is as high as up to 80 items and more, including the vehicle speed, engine RPM, engine coolant temperature, battery voltage, and other [13].

Several communication protocols have been used in OBD throughout the years. Most manufacturers have recently chosen to implement CAN protocol and all cars sold in the world after 2004 are required to implement CAN as the communication protocol for the external OBD interface [2].

## **1.2 Problem statement**

The following diagnosis statements were considered:

1. The fast growth of electronics in vehicles during the last years, vehicle maintenance has been changed to meet the new needs.

2. A complete diagnosis needs special equipment and trained technician. This is why diagnosis is very expensive.
3. The diagnosis requires driving to repair facility, so we need to identify if there is a technical problem when it happens, and know what is the problem.

### **1.3 Thesis goals**

The goal of this thesis is to develop a vehicle remote diagnostic system, which has the same functionality of conventional diagnostic, so it will be easier to collect the DTC data and real-time information immediately when an error is detected.

The collected information could be served to be accessible to the relevant authorities such as insurance companies and Maintenance Centers in addition to the vehicle owner (driver). The relevant authorities can provide the driver with the necessary information for a good response in the case of malfunction.

### **1.4 Thesis contribution**

The proposed system is capable of collecting DTC code and real-time vehicle data for a long period of time. From the aspect that it uses OBD2 protocols, and an Android mobile application as shown in Figure 1.1, monitors DTC Code by using an OBD2 Bluetooth interface [13]. If there is an error, the real-time vehicle data, and DTC Codes collected and then sent to backend web server using the smartphones 3G/4G/Wi-Fi connection. The server holds it in a database and present in the web page to relevant authorities.

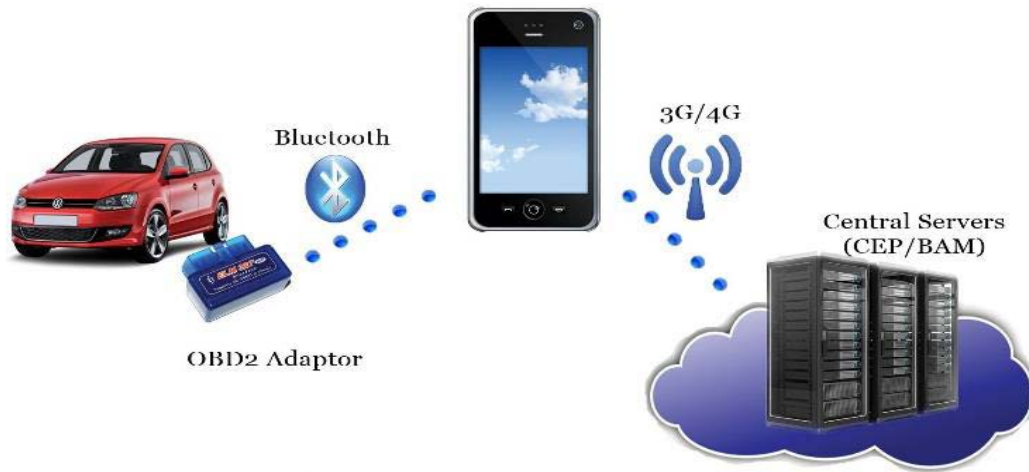

**Figure 1.1:**The proposed system.

## **1.5 Thesis organization**

The content of this thesis is arranged as follows:

*Chapter 2:* Literature review, in this chapter a detailed literature survey about The technical background information needed to understand the underlying technologies related to model design.

*Chapter 3:* Methodology, in this chapter, we present related work within the field of remote vehicle diagnostics system and then we describe our method that is proposed to achieve the goals of the data monitoring and remote diagnostics system.

*Chapter 4:* Software module, in this chapter, we will discuss the software design of the system include a brief description of the android application, web server, database and web page.

*Chapter 5: Testing and Results*, in this chapter, we present an overview to all conducted experiments, show of the main outcomes of the model, including screenshots of the Android application and the web page in addition we present evaluation and discussion here.

*Chapter 6: Conclusions and future work*, a conclusion of the overall work is given in this chapter, and the future work that can be done.

## Chapter 2:

---

### Literature Review

This chapter provides an introduction to vehicle Electronics in general, shows the component, and communication inside it. After that we focus on diagnostics which is the backbone of the On-Board Diagnostics. We then concentrate on specification and protocols that On-Board Diagnostics use, discuss data analyses like trouble codes, real-time information. Illustrates the types of communication methods, Bluetooth, and 2.5G/3G/Wi-Fi. And finally reviews the related work for the proposed system.

#### 2.1 Vehicle Electronics

An automobile is a complex product that consists of a number of subsystems such as engine, transmission, body, and other. The subsystems contain a lot of different components. All these components have to work and interact with each other to provide the transportation availability of service according to consumer demand.

Twenty years ago, most inner functions of the vehicles were executed without using electronic components, but this changed in the recent years. Electronics appear in automobiles and increased since the 1980s, where only the electronics in the car show the radio, the diodes and the voltage regulator controlled it. The last 25 years have seen rapid technological innovations in automotive electronics. The replacement of mechanical parts to electronics and also the cooperation of mechanical actuator parts with electronics,

that are known as Mechatronic, on this basic design of the overall automotive.

Automotive electronic control technology will be focused on solving the problem of automatic electronic part of the car, starting to the widely used computer network and IT development to make cars more automated, and intelligent.

In the automotive electronics it is usually divided to body electronics and system electronics:

**Body Electronics:** It is used for management and control of information processing functions that are not directly connected to the transmission of the vehicle. Examples of body electronics: lighting systems, power windows, and the information display at the dash port [4].

**System Electronics:** It is used for controlling vehicle functions that relate to the transmission of the vehicle. Examples of system electronics: an engine, powertrain, braking, and suspension [4].

## 2.2 Electronic Components

Automotive electronics consists of [basically as shown in Figure 2.1], the devices that are used to sense, compute, and actuate the different functions in the electronic system.

Operates by sensing the relevant environment, send to the ECU computer that executes the necessary action by actuating a mechanical component [5].

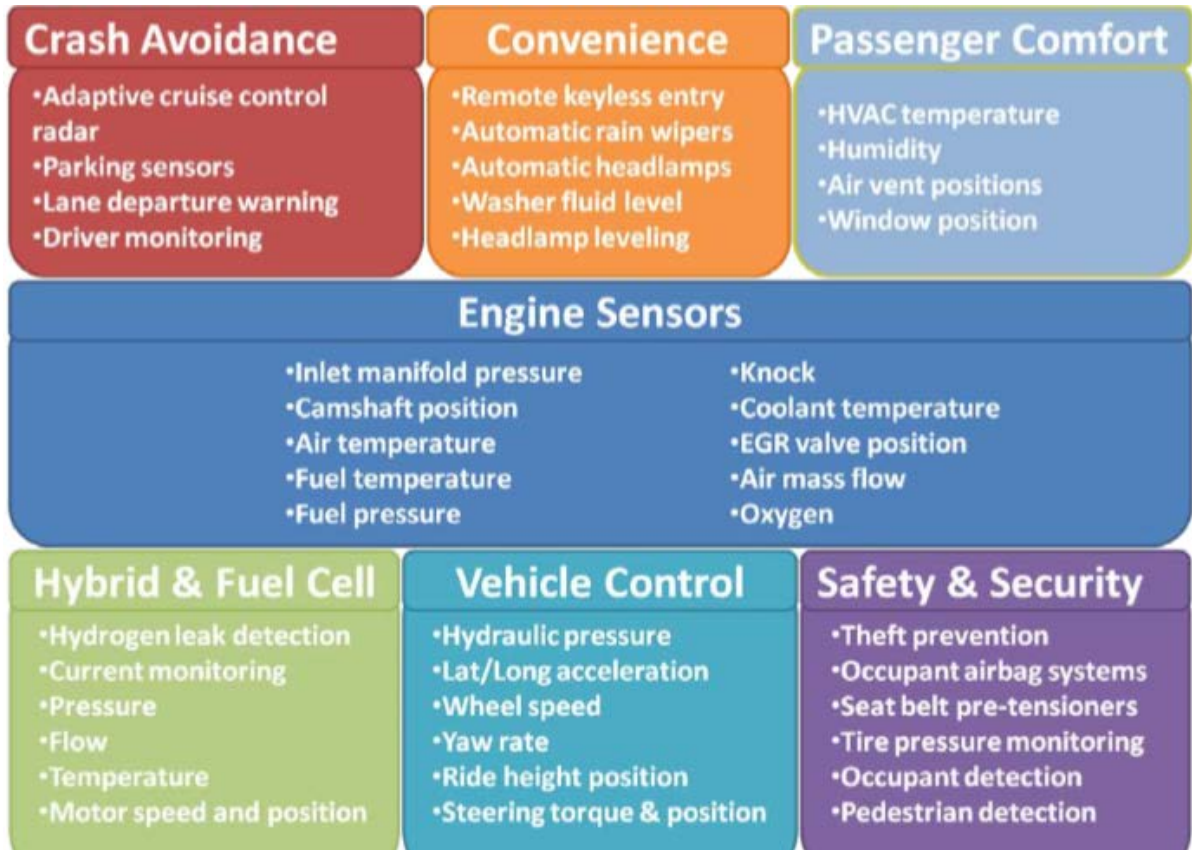

**Figure 2.1:** Basic function of an electronic system is to sense, compute & actuate.

### 2.2.1 Sensor

The sensor is an instrument that measures a physical quantity and transfers it to signals which can be understood by an electronic control unit (ECU). Most sensors are calibrated against known standards in order to be more accurate, and initially included in automobiles in the late 1980s, with the adoption of airbag sensors. It has the ability to integrate with processing and communication. Figure 2.2, shows the different type of sensor in the automobile, for example, temperature sensor, fluid level sensor, oxygen sensor, pressure sensor, and other [6].





**Figure 2.2:**Types of Automotive Sensors[7].

### 2.2.1.1 Automotive SensorsTechnologies

Because automotive applications often are specific to different sensor technologies, applications of sensor technologies are:

#### 1. Inductive sensors:

Mostly used for measuring the speed and position of a rotating element. The examples of vehicle applications of inductive sensor are:

- a. Crankshaft and camshaft sensors

- b. ABS speed sensor

## **2. Variable resistance**

Variable resistance sensors generally measure larger changes in position. This is due to lack of sensitivity inherent in the construction of the resistive track. The two best examples of vehicle applications for variable resistance sensors are:

- a. Throttle position sensor
- b. Airflow meter

## **3. Thermistors**

A device used for temperature measurement on the vehicle. The principle of measurement is that a change in temperature will cause a change in resistance of the thermistor. The thermistors are connected to indicators on the dashboard of the vehicle. Thermistors in cars are used to gather information. This allows the driver to fix his car or truck before something serious occurs.

## **4. Piezoelectric accelerometer**

It is a seismic mass accelerometer using a piezoelectric crystal to convert the force of the mass due to changes in mechanical variables (e.g. Acceleration, vibration, and mechanical shock) into an electrical output signal.

## **5. Oxygen sensor**

The vehicle application for an oxygen sensor is to provide a closed loop feedback system for engine management to control the air/fuel ratio, types of this sensor are:

- a. Oxygen sensor (Titania)
- b. Oxygen sensor (Zirconia)

## **6. Pressure sensors**

Pressure sensors monitor relative system pressure in many process applications as well as hydraulics and pneumatics. Pressure switches provide simple set point-tripped signals, while pressure transmitters provide absolute or differential analog readings over wide measuring ranges. The vehicle applications for a Pressure sensor are:

- a. Fuel pressure
- b. Manifold absolute pressure

### **2.2.2 Electronic Control Unit – ECU**

The ECU is (Electronic Control unit) uses a microcontroller to run the electronics within the vehicle. It consists of few I/O pins to connect sensors, actuators and a network interface. The basic tasks of ECU are controlled by system monitoring. Often use one microcontroller for each individual function. For example Engines, transmissions and brakes all have their own controllers[7].

The system of ECU consists of two parts: the processing part and the signal input and output port. The Pic microcontroller and other component make processing part. Input and output of ECU Communicate with each other during network interface. There are several different types of electronic control units, such as[8]:

- EECU – Engine Electronic Control Unit
- TECU – Transmission Electronic Control Unit
- VECU – Vehicle Electronic Control Unit

### **2.2.3 Actuators**

An actuator is a mechanism used as the mean device which converts electrical signals into mechanical movement to provide control to all vehicle systems, so it is a control mechanism [6].

#### **2.2.3.1 Types of Automotive Actuators**

##### **1. Motors**

Electric motors can be used in many applications in the automobiles, the output of a motor is rotational; which can convert to linear movement, and this can be used in most vehicle applications. Some typical examples of the uses of these motors:

- a. Electric windows
- b. Mirror adjustment
- c. Headlight wipers
- d. Fuel pumps

##### **2. Stepper motors**

Stepper motors have growing employment as actuators in the motor vehicle. This is mainly because of the ease in dealing with it, by which can be controlled by electronic systems.

Examples of applications of stepper motors:

- a. Air control valves
- b. Throttle body motors
- c. Idle air control valves
- d. Windshield wiper motors

### **3. Solenoid actuators**

The basic operation of solenoid actuators is very simple. Solenoid actually means many coils of wire. Good examples of a solenoid actuator are:

- a. Single-point injector
- b. Multi-point injector
- c. Speed control valve
- d. Exhaust gas recirculation valve

### **2.3 Automotive Data Buses**

Several messages are transmitted over the same signal path. These paths are known as a data bus. The data bus is basically being a couple of wires connecting the control units together. A data bus consists of a communication or signal wire and a ground return. In general, there are three types of the data bus used in vehicles. These data buses reduce the number of wires needed and allow transmit information between ECUs[6].

#### **Types of Automotive Buses**

- CAN (Controller Area Network)
- LIN (Local Interconnect Network)
- Flex Ray

We can choose the type of communication bus to use in the vehicle electrical system due to some parameter include the data rate, type of system, complexity, cost, safety and other.

Figure 2.3, shows the distributed type of the data bus on the vehicle between ECUs.

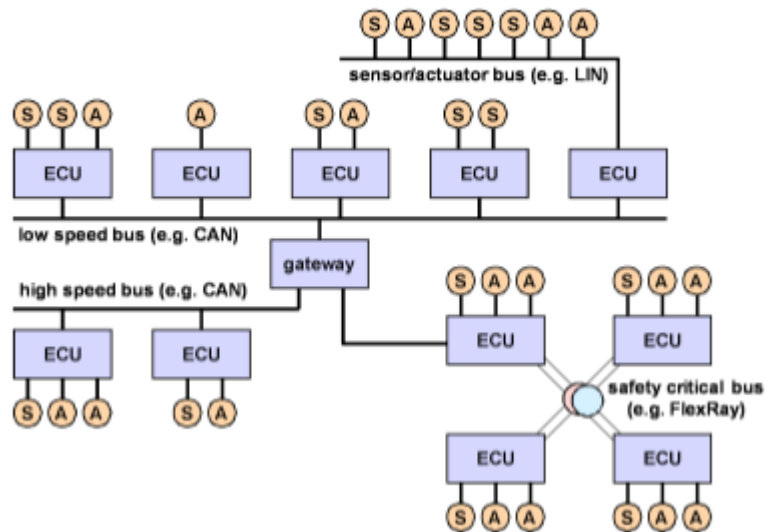

Figure 2.3: Type of data bus [9].

### 2.3.1 CAN (Controller Area Network)

Controller area network (CAN), is an International Standardization Organization (ISO) protocol developed for the automotive industry to replace the complex wiring harness with a two-wire bus [10]. The function of it is to control message transmission between ECUs connected to the same bus, developed by Robert Bosch GmbH in 1986 as a multi-master, message broadcast system that operates at data rates of up to (1Mbit/s). It has been widely used in Europe for years and has more recently become popular in the United States, gradually replacing the SAE J1850 bus which was used for diagnostics and data sharing applications in vehicles. The applications of CAN bus in automobiles include window and

seat operation (low speed), engine management (high speed), brake control (high speed) and many other systems.

### 2.3.1.1 CAN Message

It consists of voltage pulses that represent ones and zeros. The data is applied to two wires known as CAN high which is associated with a one and CAN low which is associated with a zero. The signal on one line should be a coincident mirror image of the data on the other line.

Unlike a traditional network such as USB, CAN doesn't send large blocks of data directly from node A to node B. In a CAN network, data divide into several short messages, like temperature and broadcasted to the entire network, each node decides whether it should process the message or not through the identifier of receiving messages.

### 2.3.1.2 CAN Message Frame

CAN uses short messages – the maximum utility load is 94 bits. There is no explicit address in the messages; instead, the messages can be said to be contents-addressed, that is, their contents implicitly determine their address.

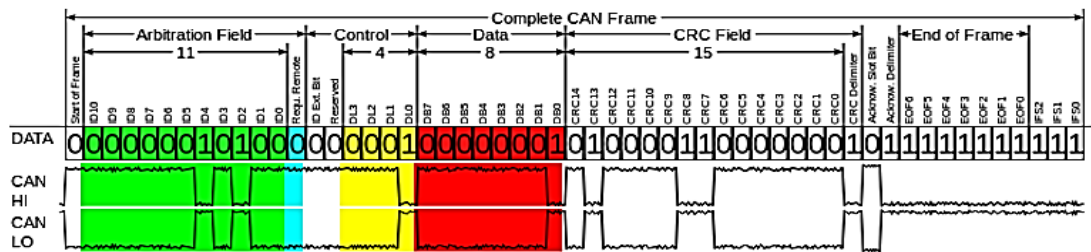

Figure 2.4: The structure of a standard CAN data frame [11].

- **SOF:** The first bit represents the start of the data frame and is known as the (SOF) bit.

- **Arbitration field:**The 11 bits that follow are used for the identifier.
- **RTR:**Which is shown in blue is the remote transmission request. Although CAN data is typically broadcast out onto the CAN bus without being solicited, it is also possible for a CAN controller to request data from another controller by utilizing the RTR bit.
- **Control:**A 4-bit data length, which is shown in yellow, is used to signify the length of the data which follows.
- **Data:** The data portion, which is shown in red, can be from 0 to 64 bits (8 bytes) in length.
- **CRC:** Following the data field,used for message integrity.
- **ACK:**The two bits that follow the CRC field are message acknowledgment.
- **EOF:**The end of frame bits is used to signify the end of the CAN data transmission.

### 2.3.2 LIN (Local Interconnect Network)

Local interconnect network (LIN) is a serial bus communication system, which is used as a sub-network of a CAN bus to integrate sensors. It has the advantage such as a low-speed, single-wire serial data bus, and low cost. It is used to control the system that's low-speed or non-safety critical functions of the vehicle like windows, mirrors, locks, heating, ventilation, and air conditioning (HVAC) units and electric seats [6].

### 2.3.3 Flex Ray

A network communications protocol was developed by the consortium of automotive manufacturers, and its choice for upgrading existing network such as CAN [6].

Flex Ray consists of two different signals, so the signal on one line should be a mirror of



the data on the other line, works on the principle of time division multiple access (TDMA). This means messages have fixed time slots in which they have limited access to the data bus. This operation is repeated and is just a few milliseconds long.

The Flex Ray protocol has been designed to carry information at a rate of 10Mbits/s over while CAN have a data rate of 1Mbit/s, so it is designed to meet the needs of current and future in-car control applications that require a high bandwidth.

The main task of it was to develop a protocol specification that can provide higher communication bandwidth with high accuracy, reliability in a work environment is of most importance, due to determinism like applications [12].

## **2.4 Diagnostics**

The fast growth of electronic functions in vehicles during the year, vehicle maintenance has been changed to meet the needs of the vehicle, in order to accurately locate, and diagnose any malfunctions. Service technicians can't depend only on visual and physical inspections to resolve vehicle problems, therefore tools and equipment are used for diagnostics to support the service technicians.

We can conclude the improved vehicle diagnostics that are necessary in order to find occurring failures in less time and cost-effective manner, so vehicle manufacturers and suppliers, thus share a common interest in minimizing expensive maintenance work [8].

### **2.4.1 On-Board Diagnostic system(OBD)**

By 1960 the topic of vehicle engine emissions influencing environmental health was very topical. This has led to an increase in the air pollution levels. Therefore, need for

regulations to reduce the influence of air pollution was necessary. So, in early 1980's a large number of vehicles started using computers, called ECU which was used to control the engine fuel-air, and emission control systems, to achieve the emission targets, quick and easy method was also developed and implemented as OBD (On-Board Diagnostics) system[13].

OBD was first introduced known as OBD I, it is based on some experience about road vehicle emission out of standard norms, CARB proposed and then implemented the first OBD requirement in April 1985, it applied to light duty vehicles beginning with the 1988 year. Although the data link connector and the communication protocols are not standardized[32].

In the year 1988, CARB prepared and implemented OBD-II. The purpose was to monitor the performance of sensors and actuators affecting the engine emission norms and finally 1996 onward applied to all vehicles, it has a standard diagnostic connector, a standard scan tool, and a standard communications protocol, the standard scan tool could use to interface with the vehicle of any manufacturer[32]. OBD-II has to monitor the following parts:

- Catalyst system
- Engine Misfire
- Evaporative emission control system
- Secondary Injection system
- Fuel system
- Oxygen Sensor
- Exhaust Gas Recirculation system
- Positive crankcase ventilation system
- Engine cooling system
- Cold start emission reduction strategy
- Air conditioning system
- Variable Valve timing system

## 2.4.2 The OBD-II specification and protocols

The OBD-II specification Provides for a standardized hardware interface, the female 16-pin(2x8) connector. Unlike the OBD-I connector, which may have been placed anywhere the vehicle, the most common location is behind the dash immediately in front of the driver, though some vehicles have the connector stashed in the center console or even behind the ashtray[14].

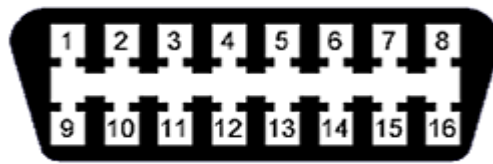

**Figure 2.5:**Pin lay-out for the DLC.

**Table 2.1:**Pin layout for OBD2 port [14].

PIN	Description	PIN	Description
1	Specific purposes	9	Specific purposes
2	J1850 Bus +	10	J1850 Bus -
3	Specific Purposes	11	Specific Purposes
4	Chassis Ground	12	Specific Purposes
5	Signal Ground	13	Specific Purposes
6	CAN (J-2234) High	14	CAN (J-2234) Low
7	ISO 9141-2 K-Line	15	ISO 9141-2 L-Line
8	Specific Purposes	16	Battery power

Looking closely we can see that there are three different electrical pairs of pin, each representing a different type of communication protocol used.J1850 (pins 2&10),CAN (pins 6&14), and ISO (pins 7&15). So in order to get information from any OBD-II

port, vehicle interface needs to know different signaling protocols are permitted with the OBD2 interface; most vehicles implement only one of them [14].

- SAE J1850 PWM (Pulse Width Modulation)
- SAE J1850 VPW (Variable Pulse Width)
- ISO 9141-2 (K-LINE)
- ISO 14230-4 (Keyword Protocol 2000)
- SAE J2284/ISO 15765-4 (CAN)[6]

#### **2.4.2.1 Type of OBD2 protocols**

##### **1. SAE J1850 PWM (pulse-width modulation): A standard for Ford Motor Company**

- Pin 2: Bus +.
- Pin 10: Bus-.
- High voltage is: +5 V.
- Message length is restricted to 12 bytes, including cyclic redundancy check (CRC).
- This protocol has a data rate of 41.6 kbaud

##### **2. SAE J1850 VPW (variable pulse width): A standard of General Motors**

- Pin 2: Bus+.
- Bus idles low.
- High voltage is :+7V.
- Message length is restricted to 12 bytes, including CRC
- This protocol has a data rate of 10.4/41.6 kbaud

### **3. ISO 9141-2: Primarily used by Chrysler, European, and Asian vehicles**

- Pin 7: K-line.
- Pin 15: L-line (optional).
- K-line idles high, with a 510  $\Omega$  resistor
- The active/dominant state is driven low with an open-collector driver.
- Message length is restricted to 12 bytes, including CRC.
- This protocol has a data rate of 10.4 kbaud and is similar to RS-232.

### **4. ISO 14230 KWP2000 (Keyword Protocol 2000)**

It is used by most European and Asian manufacturers. Alfa Romeo, Audi, BMW, Citroen, Fiat, Honda, Hyundai, Jaguar (X300, XK), Jeep since 2004, Kia, Land Rover, Mazda, Mercedes, Mitsubishi, Nissan, Peugeot, Renault, Saab, Skoda, Subaru, Toyota, Vauxhall, Volkswagen (VW) since 2001, Volvo to 2004.

- Pin 7: K-line.
- Pin 15: L-line (optional).
- Physical layer identical to ISO 9141-2
- The message may contain up to 255 bytes in the data field.

### **5. ISO 15765 CAN (250kbit/Sec or 500kbit/Sec)**

Since 2008, all vehicles sold in the United States have been required to implement CAN as one of their signaling protocols

- Pin 6: CAN High
- Pin 14: CAN Low

### **2.4.3 ELM electronic**

To obtain data from a vehicle the ELM327 OBD are used, There are several types of interfaces, the most commonly used is a chip made by ELM Electronics microcontroller. The ELM327 is the most widely used in practice, supports all OBD protocols, i.e. KWP, PWM, ISO, and CAN. It has a low power design. It is available in a low price range 3-20\$ depending on the manufacturer and the terminal type based on the terminal.

#### **2.4.3.1 Type of ELM327 interfaces**

There are 4 types of ELM327 interfaces [15].

1. ELM327 RS232 (RS or Series): This type of output is gradually disappearing from modern PCs. It is the cheapest.
2. ELM327 USB: Requires an installation of a USB driver the tethered connection is hardwired rather than wireless, Advantages all PCs are equipped with a USB port. Since it's arguably more secure and should be faster.
3. ELM327 Bluetooth: It has the advantage of being wireless and can be used with technology as a computer or a smartphone like to Wi-Fi, power consumption is something to keep in mind.
4. ELM327 Wi-Fi: Its wireless connection means it can be used with any technology such as computer or a smartphone. And the advantages of the Wi-Fi interface which can be used with the iPhone/iPad, quick, easy, and compatible with almost everything. You're also not limited to connecting just one device like you are with the USB method, but It's the most expensive one.

ELM327 USB is used almost in all PCs with a USB port and it requires installation of a specific USB driver keep a battery since it needs to be connected to a mobile phone, only

types that can be used with Bluetooth or Wi-Fi adaptors. Among them, Bluetooth adaptor was chosen because it's less expensive and typically has a lower power consumption than the Wi-Fi adaptor.



**Figure 2.6:**ELM327 Bluetooth, USB, and Wi-Fi adaptors [15].

## 2.4.4 Data Analysis

When the OBD system detects a malfunction, OBD regulations will inform the Electronic Control Unit (ECU) of the vehicle to save a standardized Diagnostic Trouble Code (DTC) about the information of malfunction in the memory. Connect OBD ELM327 interface with the OBD connector mounted on the vehicle, usually under the steering wheel. It can access the DTC from the ECU to quickly and accurately and also allow you to receive real-time information parameter.

### 2.4.4.1 Real-time information parameter

OBD-II information comes in two basic flavors, “PIDs” and “DTCs”. PIDs or known “Parameter IDs”, represent real-time information about the state of vehicle, many information can Monitor themcar such as engine RPM, calculated load value, coolant

temperature, fuel system status, vehicle speed, short term fuel trim, long term fuel trim, intake manifold pressure, timing advance, intake air temperature, air flow rate, absolute throttle position, Oxygen sensor, short term fuel trims, fuel system status, fuel pressure, and vehicle identification number.

#### 2.4.4.2 Trouble Codes

Trouble codes are used to indicate a particular problem area and are intended to provide a guide to locate where a fault might be occurring. When the OBD system found a problem in the vehicle, a trouble code is generated and saved in the ECU that responsibility for that subsystem. There are five-digit alphanumeric codes in total to represent the OBD-II malfunction as shown in Figure 2.7, the first code to stand for the established malfunction system, the second code indicates if the generic code or a manufacturer specific code, the third code shows the area from which the fault originates, the remaining two codes represent the definition of the subject malfunction [16].

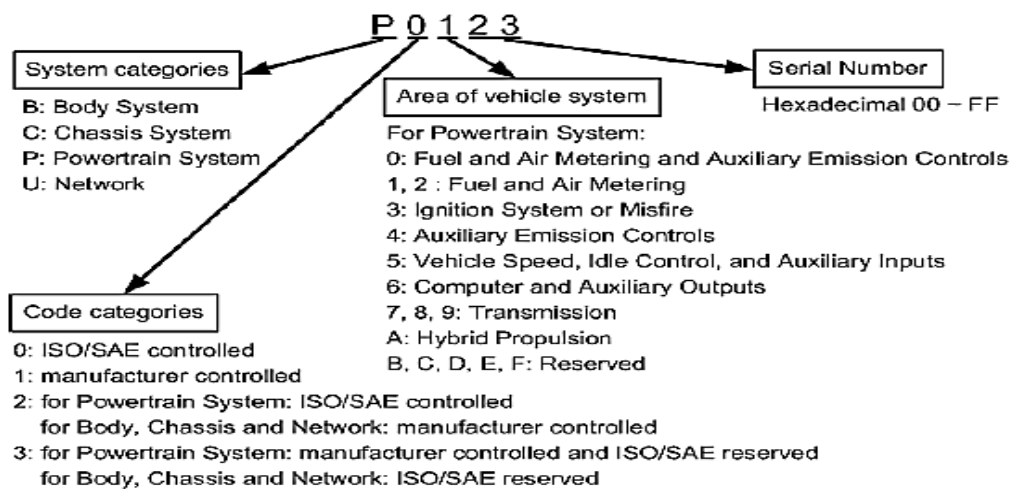

**Figure 2.7:** Definition of OBD-II Diagnostic Trouble Code.



In Table 2.2 below some of the common DTCs which occur in vehicles can be listed as follows:

**Table 2.2:** Commonly available DTCs [17].

DTC code	Description
<b>P0500</b>	Vehicle Speed Sensor Malfunction
<b>P0727</b>	Engine Speed Input Circuit No Signal
<b>P0602</b>	Control Module Programming Error
<b>C1700</b>	Left Rear Sensor Circuit Failure
<b>B1255</b>	Air Temperature External Sensor Circuit Open
<b>U2019</b>	Audio Voice Module Not Responding

## 2.5 Communication Methods

### 2.5.1 Bluetooth

Bluetooth is a wireless communications system which is intended to replace the cables connecting many types of different components. It's an excellent protocol for wirelessly transmitting relatively small amounts of data over a short range (<100m) between devices, starting from communication between mobile phones and computers, Bluetooth has expanded to enable communication between such forms as headsets, printers and automobiles. It's a secure protocol and its features as its perfect for short-range, low-power, inexpensive, and low cost, wireless transmissions between electronic devices [18].

The concept behind a Bluetooth communication is the use of masters and relationship between clients, with the master allowed to communicate with up to 7 slaves. The software will first send a page from the master to the slaves and the slaves will listen to its device access code. If there is a match, then a connection is established. Once this connection is

established, then a NULL packet is sent from the master to the slave and the master must wait for the slave to respond[13].

The range a device can communicate via Bluetooth depends on the minimum range is required by the core specification. Devices are of three types depending on their class of radio:

1. Class 3 radios – range of up to 1 meter.
2. Class 2 radios – range of 10 meters. – Most commonly found in mobile devices
3. Class 1 radios – range of 100 meters. Most commonly found in industrial use cases [19].

A smartphone that is coming each day to the market is capable of doing the large processing. Mobile phones use radio class 2.

### **2.5.2 2.5G/3G/Wi-Fi**

Wi-Fi is a wireless networking protocol that allows devices to communicate without internet wires;uses radio waves to provide network connectivity. Wi-Fi connection is established using a wireless adapter to create hotspots - areas in the vicinity of a wireless router that is connected to the network and allow users to access internet services. Once configured, Wi-Fi provides wireless connectivity to your devices by emitting frequencies between 2.4GHz - 5GHz, based on the amount of data on the network[20].

2.5G is wireless technology and capability usually associated with General Packet Radio Services (GPRS), this generation between the second and third generations of wireless technology. The second generation or 2G-level of wireless is usually identified as Global

System for Mobile (GSM) service and the third generation or 3G-level is usually identified as Universal Mobile Telecommunication Service (UMTS). Each generation provides a higher data rate and additional capabilities. This technique is currently available in telecommunications companies such as Jawwal, and Wataniya Mobile as a SIM card [21].

3G ushered in faster data-transmission speeds, so the user could use your cell phone in more data-demanding ways like for video calling, and mobile internet, provides increased bandwidth, up to 384 Kbps when a device is stationary or moving at pedestrian speed, 128 Kbps in a car, and 2 Mbps in fixed applications. This was approved by the telecommunications companies where they will be reliance extremely soon [22].

## **2.6 Related Work**

To get an initial understanding of the proposed system we read many researches, so we provide an overview of the research area, knowledge about what has been done. A lot of scientific papers illustrate system using the OBD-II like.

A Study on In-Vehicle Diagnosis System using OBD-II with Navigation by M.Kim [23]. In this study, vehicle data are collected by a suitable protocol for the vehicle type using the OBD-II automatic diagnosis connector. The collected data were wirelessly received via the Bluetooth dongle; these services are provided to the driver in the vehicle information menu of the navigation system.

Remote Vehicle Diagnostic System Using Mobile Handsets by D. H. Jung [24]. This paper concentrate on the parts of Diagnostic Trouble Codes (DTC) and MIL (Malfunction Indicator Light). As shown in Figure 3.1, the handset and automobile are connected using a converting board by cable between converting board and ECU, then selecting the type of

car system to decide the protocol to start diagnosing. According to the selected protocol between mobile handset application and a remote server, the automobile is connected to a remote diagnostic server through wireless handsets, and the data is transmitted and analyzed. After that, all the results from the vehicle displayed on the handset.

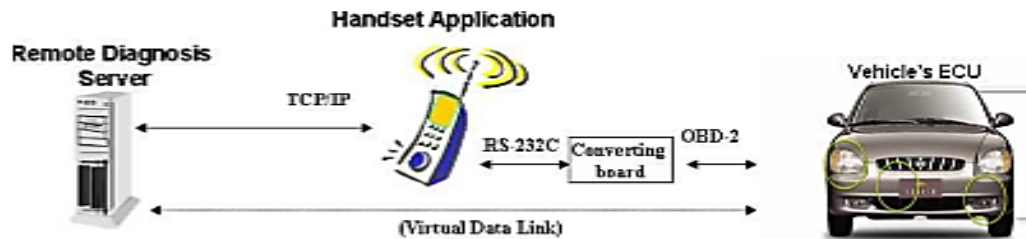

**Figure 2.8:** Configuration of the proposed vehicle diagnostic system.

A Study on Remote On-Line Diagnostic System for Vehicles by Integrating the Technology of OBD, GPS, and 3G by J. Lin [16]. In this paper, the system includes three major modules have been illustrated; on-board computer, vehicle monitor server, and vehicle status browser as shown in Figure 3.2. On-board computer is responsible for collecting the information about driving: vehicle speed, engine RPM, battery voltage, engine coolant temperature, OBD DTC, and location of vehicles, this information will be transmitted via 3G network to the vehicle monitor server where the information will be saved, and the vehicle status browser for driving real-time information to allow the user to synchronize browse the real-time information.



**Figure 2.9:** Configuration of a remote on-line diagnostic system.

Also, several types of researches [3] [13] [25] [26] look for the same system about monitoring vehicle data collected by an OBD-II adapter and recorded it through a server, consisting an ELM electronic, Android smartphone and a remote monitoring server. This mainly focuses on vehicle monitoring and displaying other data on a server.

## 2.7 State of the Art for Android Application

**Table 2.3:** Literature review of an Android application.

NO of ref	Application	Methods	Limitations
[33]	Torque	<ul style="list-style-type: none"> <li>• Torque is an OBD2 performance and diagnostic tool for any device that runs the Android operating system.</li> <li>• It will allow you to access the many sensors within your vehicles Engine Management System, as well as allow you to view and clear trouble codes.</li> </ul>	<ul style="list-style-type: none"> <li>• Close source application so we can't Connect it to my web server for transmit data.</li> <li>• Check the vehicle only when open the application and send the request to connect to the OBD-II adapter</li> <li>• Available on the Google Play Store for \$4.66.</li> </ul>
[34]	Kampana	<ul style="list-style-type: none"> <li>• Provides a real-time vehicular data monitoring system with a real-time dashboard of your vehicle with not only speed, RPM, but also coolant temperature, sensor values and many more PIDs that supports with OBD2.</li> <li>• Kampana supports ELM 327 OBD2 Bluetooth adapter to connect the application to the vehicle ECU.</li> <li>• Uploading data to online servers</li> </ul>	<ul style="list-style-type: none"> <li>• Close source application so we can't Connect it to my web server for transmit data.</li> <li>• This system focuses on real-time data only without diagnostic information.</li> <li>• Check the vehicle only when open the application and send the request to connect to the OBD-II adapter</li> </ul>
[35]	OBDDoctor	<ul style="list-style-type: none"> <li>• Android / iOS mobile application that connects to vehicle's on-board diagnostic computer using OBD-II protocols via Bluetooth/Wifi adapters. The app gives wide opportunities for the on-board diagnostics of the car.</li> <li>• Read, record and store parameters in real-time and view it in form of charts and graphs</li> <li>• Upload to server</li> </ul>	<ul style="list-style-type: none"> <li>• Check the vehicle only when open the application and send the request to connect to the OBD-II adapter.</li> <li>• Close source application so we can't Connect it to my web server for transmit data</li> <li>• Available on the Google Play Store for \$10.40</li> </ul>

## Chapter 3

---

### Methodology

In this chapter, we clarify architecture of the proposed system, explain it in details by prototype topology, and show working principle using flowcharts.

#### **3.1 Architecture for the system**

##### **3.1.1 Topology of prototype**

The overall basic system's blocks are shown in Figure 3.1 and each block expresses components of the system which can be divided into two parts. Hardware that consists of vehicle, OBD adapter, and Bluetooth. The software consists of a smartphone application, server, and webpages for relevant authorities, such as owner vehicle, maintenance center, and insurance company.

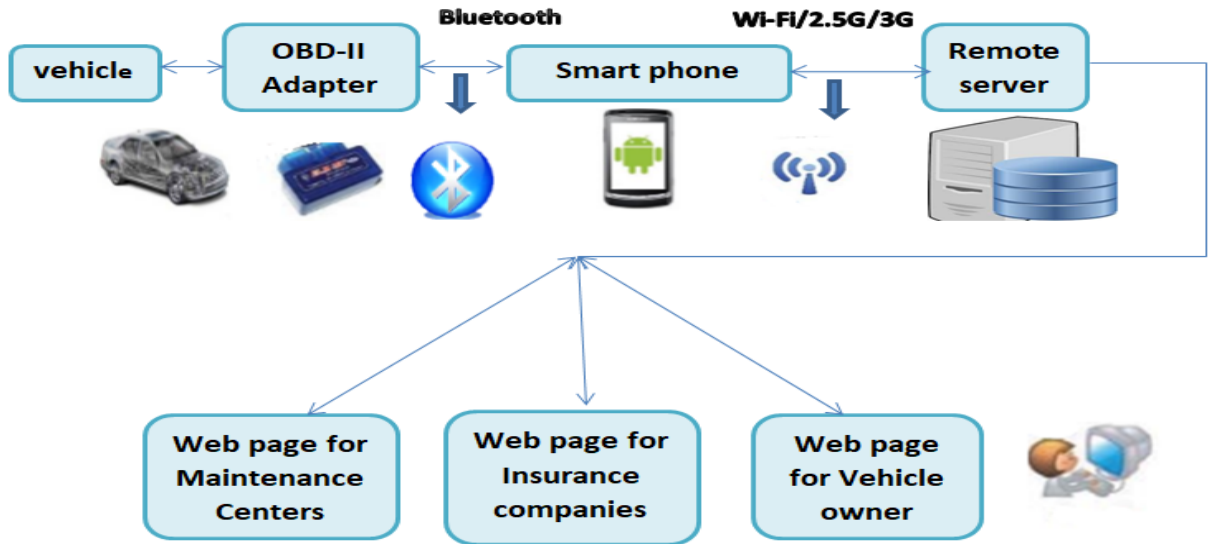

Figure 3.1: Topology of prototype architecture system.

### 3.1.2 System Flowchart

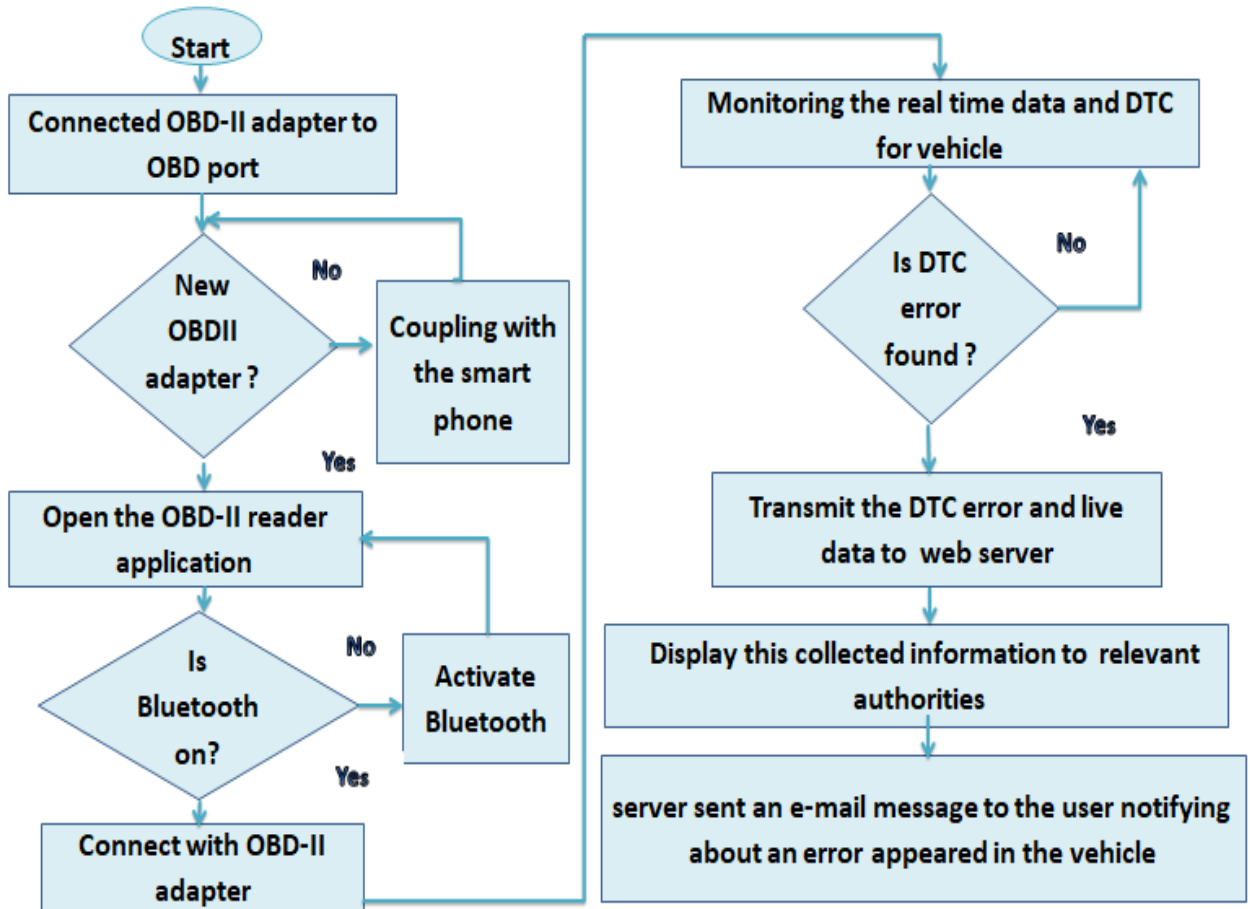

Figure 3.2: System flowchart



In order to achieve diagnostic, the proposed system is capable of reading, storing, and analyzing vehicular data for a long period of time. As shown in Figure 3.4, our prototype flowchart demonstrates how the system works. After connecting the OBD adapter with vehicle ECU interface through OBD-II port, the OBDII reader application on a smartphone is connected to the OBD adapter via Bluetooth, sends requests to the OBDII system in the vehicle to transmit data, then the transmitted data is received automatically by the smartphone.

Received data could be displayed on a smartphone, when there is a DTC error in the vehicle, all data is sent to the web server via the Wi-Fi/2.5G/3G connection.

The server that contains the database holds a table, the data will be stored in this table. All results could be displayed on the web interface. And the server sent an e-mail message to the user notifying about an error appeared in the vehicle to check his web page and know the detailed about it.

## Chapter 4

---

### Software module

This chapter discusses the software module of the system. Firstly, we clarify the application that we use; functionality and phases of development. Then we talk about the web server, explaining the mechanism of data transmission, and data storage on the web server. Finally, we demonstrate in details the database part of the system.

#### 4.1 Vehicle owner Android Application Software

##### 4.1.1 Android OBD-II Reader

Android application is the key device that responsible for data transmission between the OBDII adaptor and web server. It is available as open source on the WEB containing both (APK) and source code [32].

Originally, the downloaded application has been limited DTC error code and live data features. It was necessary to be modified to achieve the required results from the system. We used Android Studio as a platform for developing our Android application.

Android Studio is an integrated development environment (IDE) for the Android platform and is free for all the developers. The Android Studio is designed specifically for Android development. The major advantage of using this platform is the easiness when debugging the application. Android Studio enables us to debug the application running on the emulator or

on an Android device. Which is based on the JAVA programming language, because the Android SDK as all of the Android APIs are built on the JAVA programming language. Our developed application is capable of playing the following three major roles:

- 1) Receiving Data from the OBD-II Adapter: Vehicle ECU is connected to the OBD-II port, vehicle, and OBD-II reader exchanges data. The application is capable to be connected to the ELM-327 adaptor via Bluetooth.
- 2) Monitoring vehicle: The application has the ability to get DTC code and real-time data from the vehicle, and to check DTC error code every 10 minutes. This is done to make sure that there is no malfunction in the vehicle.
- 3) Sending Data to the web server: Any DTC error code and real-time data on the vehicle are transmitted over a 2.5G/3G/Wi-Fi network. The transmitted data like a text with a small size so it's low packet size and battery consumption. Figure 4.1 shows the main GUI page of the mobile application.

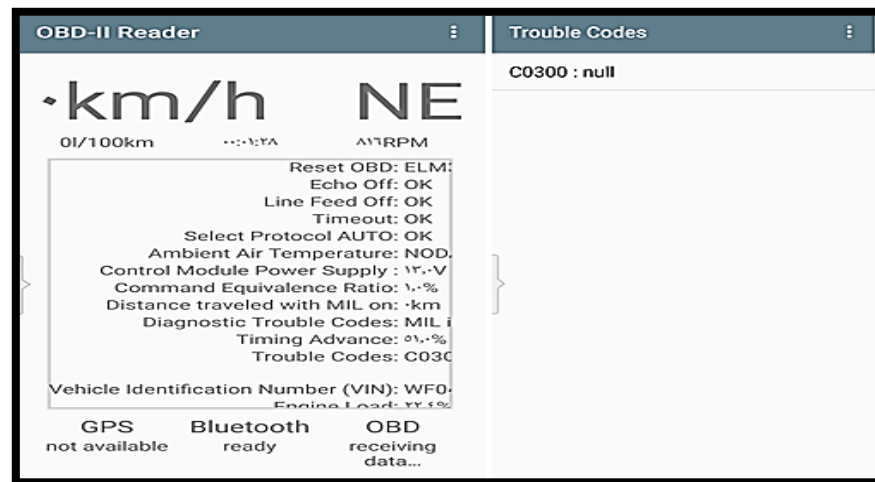

Figure 4.1: Configuration of the mobile application.

As shown, the real-time data are display on the left, while any possible DTC code is displayed on the right of the screen.

#### 4.1.1.1 Real-time Parameters

The Android mobile application is designed to read and display in real time the set of vehicle PID parameters [27]. The parameters are listed in Table 3.1. As shown

**Table4.1:** List of all Parameters.

Compass	Integrated into the app to show the direction of the vehicle
Speed	Shows the speed of the vehicle in mph
Engine RPM	It is a measure of crankshaft rotation of the engine per minute
Engine Load	Is a measure of work being done by an Engine
Engine Runtime	Is a measure of time from the start of the engine until the engine shut off
Engine Coolant Temperature	It is used to determine the temperature of the engine coolant
Throttle Position	This function tells us the exact throttle position of the vehicle at any given time
MAF	It is used to find out the mass flow rate of air entering a fuel-injected internal combustion engine
Air-Fuel Equivalence Ration	Air-fuel ratio (AFR) is the mass ratio of air to fuel present in a combustion process
Timing Advance	It is the measure of ignition spark fired by the spark plugs at a given time
Fuel Level	Fuel Level Input is the percentage of fuel by 0%, equaling tank is full and 100% when tank is empty
Distance travel with MIL	Show the distance that the vehicle travel in meter
Selected protocol	Shoe the protocol that the vehicle use, which selected by the user
VIN	Vehicle identification number
Fuel Pressure	Is the fuel pressure at the engine when reading in reference to atmospheric pressure
Trouble Codes	A trouble code is an alphanumeric value that corresponds to a particular type of fault in a vehicle
Air Intake Temp	Air intake temperature is actually an air temperature inside the intake manifold, should be very close to Ambient air temperature
Intake Manifold Pressure	Displays manifold pressure. Normally, it should always be in a state of vacuum
Barometric Pressure	It is actually an atmospheric pressure of the vehicle's surroundings

#### 4.1.1.2 Android application on Flowchart

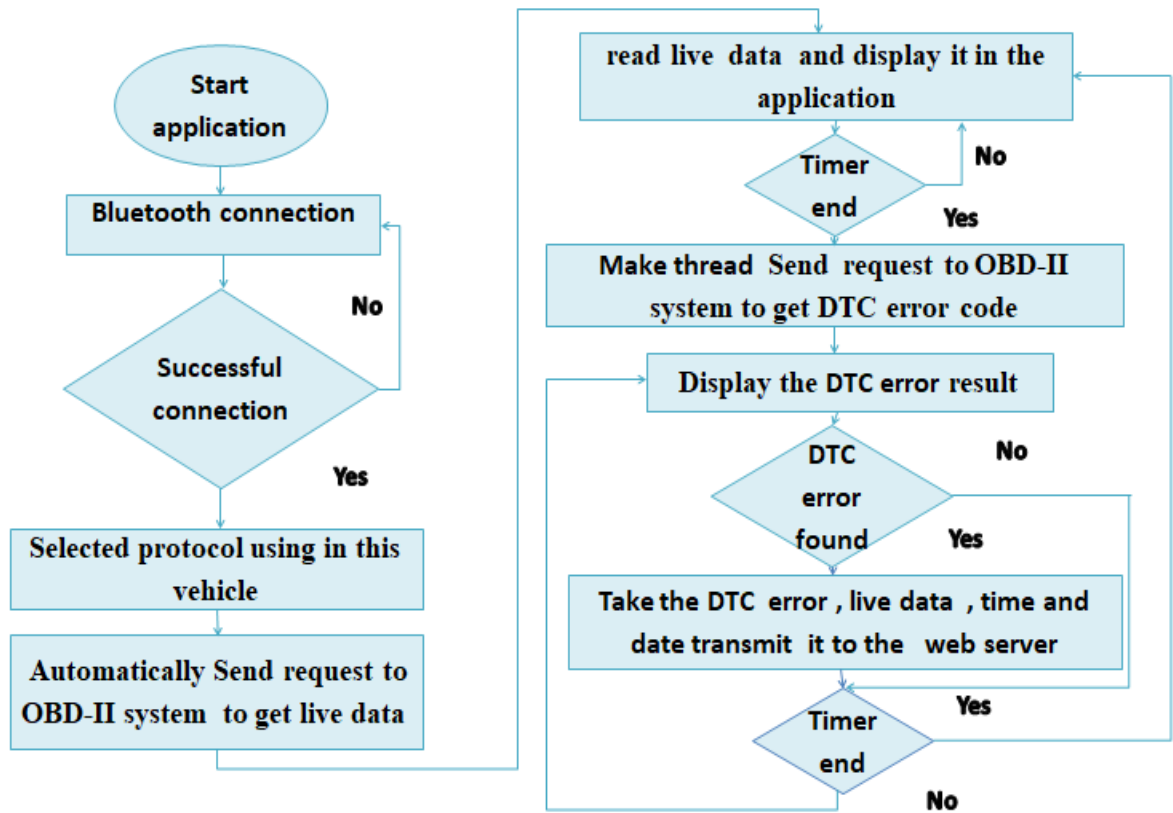

Figure 4.2: Flowchart to work application.

**First**, after connecting the application with OBD interface and receiving the live data, it could be monitored on the Smartphone.

**Secondly**, after 10 minutes it makes threads to disconnect OBD interface and swiped to DTC error.

**Thirdly**, it is re-connected to OBD interface and gets the DTC error (if any).

**Fourthly**, transfer the DTC error code and live data, including time and date to the web server.

**Fifthly**, one minute later, it makes a thread again to disconnect the OBD interface and transfer to live data.

The developed mobile application menu allows the user to realize personal settings such as turning GPS ON/OFF, vehicle suitable protocol and the desired parameters to be read and displayed.

## **4.2 Vehicle owner remote server**

The vehicle information acquired by integrating the OBD system with a mobile application, including the vehicle speed, engine RPM, battery voltage, engine coolant temperature, fuel level, AIR /FUEL ratio, DTC, VIN, time, and other data is transferred to the web server.

### **4.2.1 Web Server**

The server, which is held at the maintenance department where the information is stored in the database. So, we can assign an access to specific authority.[13] The Web server is a type of a PHP programmed server that knows how to communicate with clients using the Hypertext Transfer Protocol (HTTP) HTTP/TCP packets. This protocol is usually used for communication between server and client with a set of rules. TCP is used over UDP because it can guarantee that the transferred data remains intact and arrives in the same order as it was sent. The server should have a static and public IP address to which the application packets are destined. The server contains MySQL database. The database holds a table. So, the mobile application transfers data via WI-FI/2.5G/3G from the integrated OBD system and recorded in the table.

## 4.2.2 Data transmission to the server

With the release of a new generation intelligent phone Android and global 3G/2G network into operation [28], the communications between intelligent phone platform and database server become more important. Data can typically include: Text, Images or videos. HTTP protocol allows us to send data to the server in different formats such as XML, or JSON. The server should be ready to handle data in the selected format. In our model, we use the JSON data format as the transmission medium.

### 4.2.2.1 JSON (JavaScript Object Notation)

JSON is a text format for exchange data that is completely language independent, but uses conventions that are familiar to programmers of the C-family of language, including C, C++, C#, Java, JavaScript, Python, and many others. These properties make JSON an ideal data-interchange language which is easy to read and write, it is also easy to analysis, and generating machines. The data format is simple; it can be read and written easily. The format is compressed and the bandwidth it takes up is small. It has high efficiency and it is more suitable for the mobile phone application transmission in time [29].

The universal data structure built by JSON is supported in all programming languages and has two structures:

1. A collection of name/value pairs. In various languages, this is realized as an *object*, record, struct, dictionary, hash table, keyed list, or an associative array.
2. An ordered list of values. In most languages, this is realized as an *array*, vector, list, or sequence.

```

"direction" : {
  "Reset OBD" : "UNABLETOCONNECT",
  "Echo Off" : "ATE00K",
  "Line Feed Off" : "OK",
  "Timeout" : "OK",
  "Select Protocol AUTO" : "OK",
  "AMBIENT_AIR_TEMP" : "NODATA",
  "CONTROL_MODULE_VOLTAGE" : "\r,.V",
  "EQUIV_RATIO" : "\,.%",
  "DISTANCE_TRAVELED_MIL_ON" : ".km",
  "DTC_NUMBER" : "4101004761001:06410100040000",
  "TIMING_ADVANCE" : ".\,.%",
  "TROUBLE_CODES" : "",
  "VIN" : "C",
  "ENGINE_LOAD" : "\r\,.%",
  "ENGINE_RPM" : "\.\ RPM",
  "ENGINE_RUNTIME" : ".\:\.\:.\",
  "MAF" : "NODATA",
  "THROTTLE_POS" : "\,.\,.%",
  "FUEL_TYPE" : "NODATA",
  "FUEL_CONSUMPTION_RATE" : "NODATA",
  "FUEL_LEVEL" : "\r\,.%",
  "Long Term Fuel Trim Bank 1" : "\r,.\%",
  "Long Term Fuel Trim Bank 2" : "NODATA",
  "Short Term Fuel Trim Bank 1" : "\r,\%",
  "Short Term Fuel Trim Bank 2" : "NODATA",
  "AIR_FUEL_RATIO" : "\,.\,.\:1 AFR",
  "ENGINE_OIL_TEMP" : "NODATA",
  "BAROMETRIC_PRESSURE" : "\.\.\kPa",
  "FUEL_PRESSURE" : "NODATA",
  "FUEL_RAIL_PRESSURE" : "NODATA",
  "INTAKE_MANIFOLD_PRESSURE" : "\,.\kPa",
  "AIR_INTAKE_TEMP" : "\rC",
  "ENGINE_COOLANT_TEMP" : "\rC",
  "SPEED" : ".km/h",
  "date" : "\.\.\-\.\.\-\.\.",
  "time" : "7:20",
  "Error" : "No error"
}

```

Figure 4.3: JSON document of vehicular data.



### 4.2.3 Database

The next step was to store the incoming data in the database. The database handles the data model. Any request made from the client application or any response will be forwarded via the web server to be stored in Database. We chose MySQL database. SQL is Structured Query Language, which is a computer language for storing and retrieving data stored in a relational database. The data is stored in database objects which are called as a table. A database most often contains one or more tables. Each table is identified by a name [30]. To handle the data within the database, our server contains three tables: vehicles table, users table, role table

- **Vehicles table** holds information about the status of the vehicle when DTC error occurs. As shown in Figure 4.3, the table consists of columns id, dtc\_code, code description, date\_time, distance \_traveled\_ mil, engine speed, engine load, engine runtime, vehicle speed, throttle position, coolant temperature, air intake temperature, intake manifold pressure, control module voltage, fuel level, air fuel ratio, and VIN.

#	الاسم	النوع	Collation	الخواص
1	id	int(11)		
2	dtc_code	varchar(500)	utf8_general_ci	
3	code_description	varchar(500)	utf8_general_ci	
4	date_time	varchar(500)	utf8_general_ci	
5	distance_traveled_mil	varchar(500)	utf8_general_ci	
6	engine_speed	varchar(500)	utf8_general_ci	
7	engine_load	varchar(500)	utf8_general_ci	
8	engine_runtime	varchar(500)	utf8_general_ci	
9	vehicle_speed	varchar(500)	utf8_general_ci	
10	throttle_position	varchar(500)	utf8_general_ci	
11	coolant_temperature	varchar(500)	utf8_general_ci	
12	air_intake_temperature	varchar(500)	utf8_general_ci	
13	intake_manifold_pressure	varchar(500)	utf8_general_ci	
14	control_module_voltage	varchar(500)	utf8_general_ci	
15	fuel_level	varchar(500)	utf8_general_ci	
16	air_fuel_ratio	varchar(500)	utf8_general_ci	
17	vins	varchar(500)	utf8_general_ci	

Figure 4.4: Vehicles table structure in the database.

• **User table** holds information about the vehicle owner, it is registration at the beginning of the creation his own page and associated with his vehicle information (vehicle table) by VIN for the vehicle. As shown in Figure 4.4, the table consists of columns id, identifier, name, email, mobile, role\_id, VIN, and password (hashed using the MD5 algorithm).

#	الاسم	النوع	Collation	الخواص
1	id	int(11)		
2	identifier	varchar(200)	utf8_general_ci	
3	name	varchar(500)	utf8_general_ci	
4	email	varchar(500)	utf8_general_ci	
5	password	varchar(500)	utf8_general_ci	
6	mobile	varchar(500)	utf8_general_ci	
7	role_id	int(11)		
8	vin	varchar(500)	utf8_general_ci	

Figure 4.5: User table structure in the database.

•**Roles table** holds information about relevant authority, such the vehicle owner,maintenance center,and insurancecompany as shown inFigure4.5 andFigure4.6. The table consists ofid, and role \_name.



**Figure 4.6:**Role table structure in the database.



**Figure 4.7:**The type of role name.

#### 4.2.4 Web interface

It offers the interface between the system and relevant authorities: insurance companies, maintenance centers, and vehicleowner. The web interface is built in a method thatcould present information inthe most correct and suitable way. Any request from relevant authorities will be reported to the server and are a sponse to a request about vehicle information will appear on a web page as will be presented in section 5.1.3

## Chapter 5

---

### Model Testing and Results

#### 5.1 Testing

Testing of the realized model was incrementally done during the development. After the realization of the overall system, an integral testing performed on both software and hardware.

##### 5.1.1 Hardware Testing

Our hardware includes smartphones, Bluetooth OBDII adapter, vehicle OBD-II port, and vehicle.

###### 5.1.1.1 Vehicles sample

Five vehicles are subjected to the test. The vehicles set includes 2006 Ford Focus, 2015 Kia Pride hatchback, and 2014 Hyundai Accent, Seat Leon 2015, and Golf GTI 2012. OBD-II ports were subjected to visual inspection functionality. These ports and pins must be conformed with used the OBDII interface.

###### 5.1.1.2 Hardware interface

We used the ELM327 OBD-II Bluetooth adapter. Samsung Note 4 that has Android software 6.0.1 version is used.

## 5.1.2 Software Testing

The Android Application testing on multiple vehicles after it had been developed and the required functionality has been achieved.

We built and use a real server. We have an access to the server for a limited period against certain fees. The page has been tested by using the VIN number for maintenance center, and the owner ID number to the insurance company to research of the vehicle and user in the database. The following section shows the various web pages assigned to relevant authorities and presents some screenshots for important information on each page.

## 5.1.3 WEB Pages

The first web page prompts the user to select the Button that shows the name of the relevant authority as shown in Figure 5.1: vehicle owner, maintenance center, and insurance company.

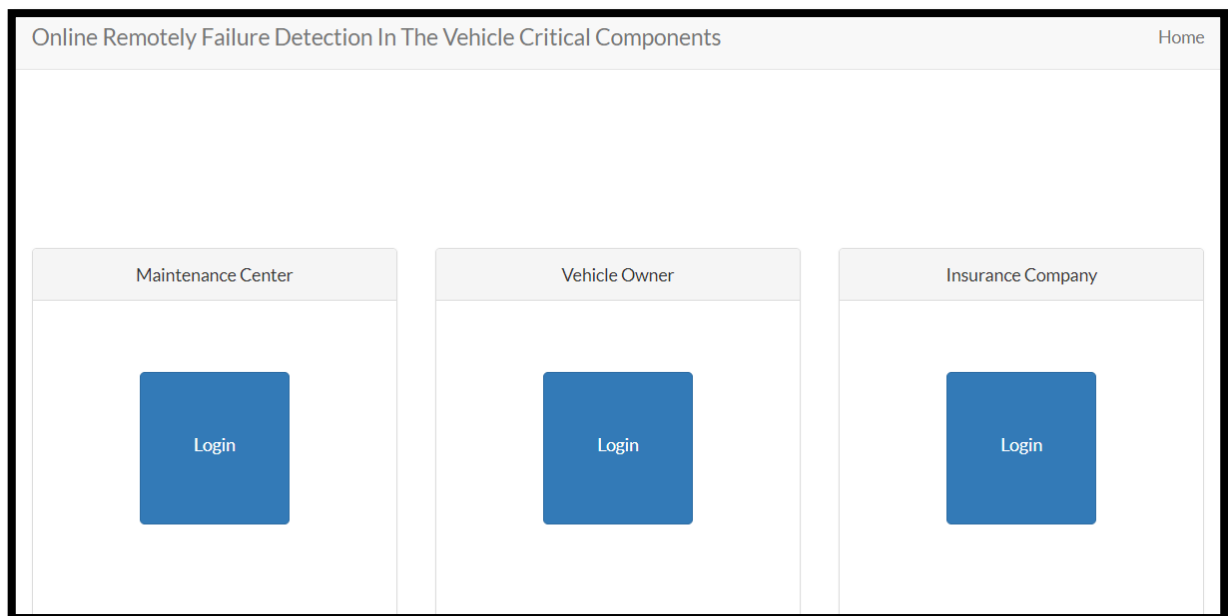

**Figure 5.1:** Screenshots of the main page.

After selecting the button, we are directed to login page, with a note when registering for the new vehicle owner, basic information such as name, mobile number, e-mail address, and ID number must be entered to save as shown in Figure 5.2.

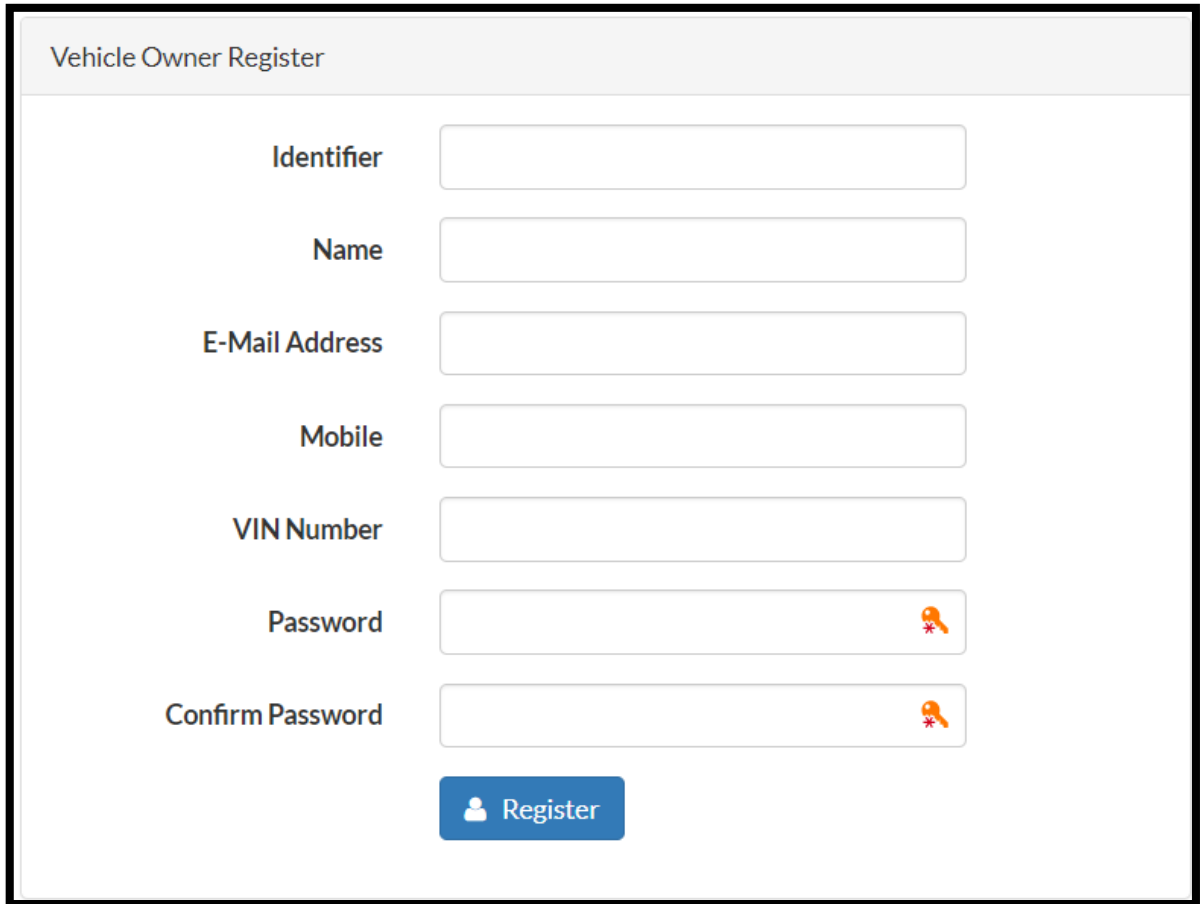

The screenshot shows a web form titled "Vehicle Owner Register". The form contains several input fields for user registration: Identifier, Name, E-Mail Address, Mobile, VIN Number, Password, and Confirm Password. Each field is accompanied by a small orange icon of a person with a red asterisk, likely indicating a required field. Below the input fields is a blue button with a white person icon and the text "Register".

**Figure5.2:** Screenshots for logger new user page.

### 5.1.3.1 Vehicle owner page

Upon logging by user and password entered by the user, the home page is shown in Figure 5.3 contains the basic information that the vehicle owner knows, also, this page allows the user to able monitoring remotely driving information and any DTC error.

General Information		Ambient Condition	
Name Of Vehicle Owner:	tujan	Date Time:	۲۰۱۹-۰۹-۲۰ ۱۷:15
Mobile Number:	0598450600	Distance Traveled MIL:	۰ km
E-mail Address:	tujan.tammam@gmail.com	Vehicle Speed:	۰ km/h
VIN Number:	WF04XXWPD65C50241	Engine Runtime:	۰۰:۰۵:۰۷
ID Number:	854190774	Engine Speed:	۷۹۳RPM
Fault Inforamtion			
DTC Code:			
DTC Description:			

**Figure5.3:** Vehicle owner page (user account).

### 5.1.3.2 Maintenance center

Upon logging, the home page appears, according to an entry vehicle VIN number as shown in Figure 5.4.

Vehicle Identification Number
<p>Vehicle Identification Number</p> <p>WF04XXWPD65C50241</p> <p>Display</p>

**Figure5.4:** Vehicle VIN search screen.

As shown in Figure 5.5, the table displays the time and date at which the DTC error appeared in the vehicle, they are arranged in a way that new DTC error appears at the

beginning of the table.

Vehicle Identification Number Table			
#	VIN	Date	Details
1	WF04XXWPD65C50241	۲۹-۰۹-۲۰۱۷ 8:15	<a href="#">Details</a>
2	WF04XXWPD65C50241	۲۹-۰۹-۲۰۱۷ 7:27	<a href="#">Details</a>
3	WF04XXWPD65C50241	۲۹-۰۹-۲۰۱۷ 7:22	<a href="#">Details</a>
4	WF04XXWPD65C50241	۲۹-۰۹-۲۰۱۷ 7:21	<a href="#">Details</a>
5	WF04XXWPD65C50241	۲۹-۰۹-۲۰۱۷ 7:20	<a href="#">Details</a>
6	WF04XXWPD65C50241	۲۹-۰۹-۲۰۱۷ 7:12	<a href="#">Details</a>
7	WF04XXWPD65C50241	۲۹-۰۹-۲۰۱۷ 7:12	<a href="#">Details</a>

**Figure5.5:** Vehicle information.

After selecting the button to show details about the vehicle when a DTC error appears, basic information, fault information, standard ambient condition, and extended ambient condition of the vehicle are shown in Figure 5.6.



General Information		Fault Information	
Name Of Vehicle Owner:	tujan	DTC Code:	
Mobile Number:	0598450600	Code Description:	
E-mail Address:	tujan.tammam@gmail.com		
VIN Number:	WF04XXWPD65C50241		
ID Number:	854190774		
		Standard Ambient Condition	
		Date Time:	٢٢-٠٩-٢٠١٧ 10:03
		Distance Traveled MIL:	٠ km
Extended Ambient Condition			
Engine Speed:	٨٢٩RPM	Air Intake Temperature:	٦٢C
Engine Load:	٢٣,٩%	Intake Manifold Pressure:	
Engine Runtime:	٠٠:٠٢:٠٠	Control Module Voltage:	١٣,٠V
Vehicle Speed:	٠ km/h	Fuel Level:	٢٧,٨%
Throttle Position:	١٥,٣%	Air-Fuel Ratio:	١٤,٧٧:1 AFR
Coolant Temperature:	٧٩C		

**Figure5.6:** Maintenance center page.

### 5.1.3.3 Insurance Page

Our model allows the insurance companies access remotely technical information about the vehicle, after logging in as shown in Figure 5.7, an entry about owner ID number search appears.

ID Number

---

ID Number

Display

**Figure5.7:** Owner ID number searching.

After selecting the button to show the details about the vehicle when an error appears, we show a page that contains vehicle driving information, diagnostic information, and ambient condition sensor information as shown in Figure 5.8.

General Information		Fault Information			
Name Of Vehicle Owner:	tujan	DTC Code:			
Mobile Number:	0598450600	Code Description:			
E-mail Address:	tujan.tammam@gmail.com				
VIN Number:	WF04XXWPD65C50241				
ID Number:	854190774				
Standard Ambient Condition					
Date Time:	٢٢-٠٩-٢٠١٧	10:03			
Distance Traveled MIL:		٠	km		
Extended Ambient Condition					
Engine Speed:	٨٢٩	RPM	Vehicle Speed:	٠	km/h
Engine Load:	٢٣,٩%		Throttle Position:	١٥,٣%	
Engine Runtime:	٠٠:٠٢:٠٠		Fuel Level:	٢٧,٨%	

**Figure5.8:** Data page for ininsurance companies.

## 5.2 Results

In order to authenticate the proposed system, we display the test result, such one of the vehicles as the following:

Testing Ford Focus (model 2006) that uses the CAN protocol. The application (on Galaxy note 4) has been run to monitor vehicle status. A Bluetooth ELM327 is connected to the vehicle OBD II port. A DTC error code P0007 has appeared. This error stands for fuel shut

off valve control circuit high, and information relevant to the car was shown as well; driving date/time, vehicle speed; engine RPM, battery voltage, coolant temperature, engine load and other.

This test showed that the system works as intended and gives the desired results. The data is sent successfully to the web server and it is stored in the database table, the server sent an e-mail message to the user notifying about an error appeared in the vehicle to check his web page. Results in the email message, webpage, and smartphone to the user are shown in Figure 5.9, figure 5.10, and figure 5.11.

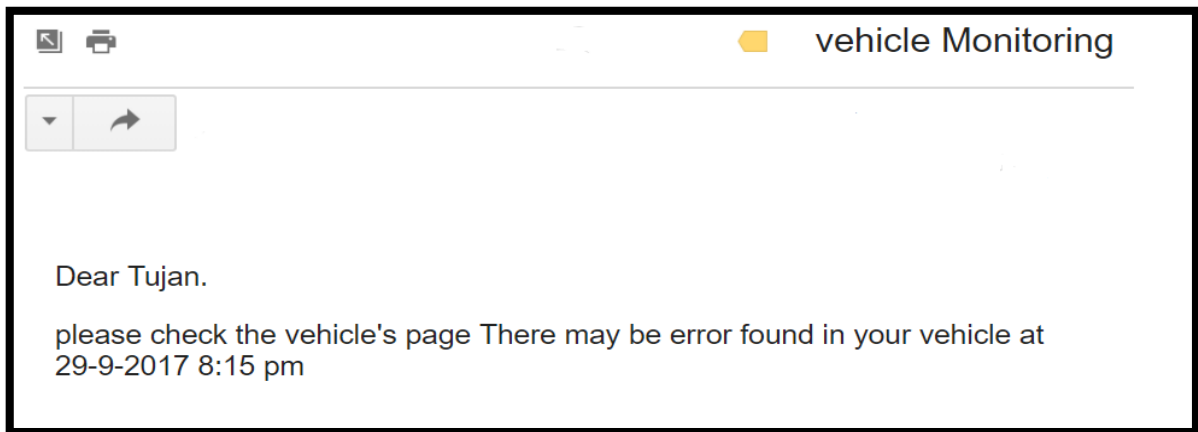

**Figure 5.9:** Screenshot of the email message has been sent to the user when error found.

General Information		Ambient Condition	
Name Of Vehicle Owner:	tujan	Date Time:	۲۹-۰۹-۲۰۱۷ 8:15
Mobile Number:	0598450600	Distance Traveled MIL:	۰ km
E-mail Address:	tujan.tammam@gmail.com	Vehicle Speed:	۰ km/h
VIN Number:	WF04XXWPD65C50241	Engine Runtime:	۰۰:۱۵:۰۷
ID Number:	854190774	Engine Speed:	۷۹۳ RPM
Fault Inforamtion			
DTC Code:	P0007		
DTC Description:	Fuel Shutoff Valve A Control Circuit High		

**Figure 5.10:** Vehicle owner page.



**Figure 5.11:** Screenshot of mobile application when error found.

- The table (5.1) shows the tested vehicles byour system.

**Table 5.1:** Test vehicles table.

Manufacture	Model	Year	Type of protocol	Result
<b>Kia</b>	Pride	2015	CAN	Nofaults
<b>Hyundai</b>	Accent	2014	CAN	Nofaults
<b>Seat</b>	Leon	2015	CAN	Faults
<b>Golf</b>	GTI	2012	CAN	Faults

## 5.2.1 Obtained data

### 5.2.1.1 Data size

The size of transmitting data varies; it depends on the number of parameters selected to be tested. When there are an OBD detected ( $N$ ) errors, transmitted data to the server will be

$(2K + 2 * N)$  Bytes.

### 5.2.1.2 Performance

In general, the performance of our system is sensitive to data latency. It degrades when the perpetual/ weak connection interruption occurs. Latency greatly affects how usable and enjoyable electronic and mechanical devices, as well as, communications are [31]. For us, latency represents the end-to-end delay in real-time data transmission.

### **5.2.1.3 Security issues**

Data is sent from the OBD II interface to mobile as text, during the data transmission to the server many issues could arise. Since the data is sent as a plain text, it could be read by unauthorized parties in various ways, which makes the vehicle unsafe for normal operations. To solve this problem, an encryption mechanism when transmitting data packets from mobile to the server is applied in order to be protected from attempts to hack data by an attacker. At the server, the packet will be decrypted to recover the original data.

## **5.3 Evaluation**

### **5.3.1 Limitation**

During the different phases of my research and model implementation, many challenges have been faced. These limitations are:

- Most times of vehicle testing, no trouble codes are detected. This was an obstacle factor that relatively affects the evolution of our work.
- Most trouble codes are generic, and not all manufacturers want to share this information about all trouble codes, so collecting trouble code for all manufacturers is not easy.
- The major obstacle of the proposed system was the data transfer from mobile to the server. If the driver mobile has no internet connection, the system doesn't work.
- Mobile Bluetooth power consumption influences the smartphone battery time.
- Unavailable for 3G service yet.

### 5.3.2 Features of the model

#### 1. Flexibility

The vision for the system was to create an architecture for a new remote diagnostic system to help relevant authorities such as insurance companies and Maintenance Centers.

#### 2. Availability

By making vital vehicle information (such as DTCs and condition of the vehicle) accessible to authorized users even though the vehicle is a far from it.

#### 3. Reliability

Receive data using remote diagnosis system online in real-time, without issue for long distances.

#### 4. Benefit for relevant authority:

**Vehicle owner** as self-evaluation of driving. Ability to monitor the status of the vehicle such as faults.

**Insurance companies** could reward good drivers by reducing their premium. Monitor and manage vehicles by notifying unusual behaviors of drivers.

**Maintenance Centers** data can be directly forwarded to the vehicle manufacturer's production or other departments needed this information. Analysis of large amounts of preserved vehicle data may detect problems that have occurred or may occur with specific vehicle model. Provide a new kind of services based on the proposed system, may bring the convenience of the vehicle owner.

## 5.4 Discussion

- The performance of the complete integrated proposal system which consists of the combination of low-cost hardware unit such ELM electronic, and mobile smartphone application based on Android, vehicle remote server, and three different web pages for insurance companies, maintenance center and also vehicle owner.
- The mobile application design to communicate with the hardware interface unit via Bluetooth to monitor and receive vehicle information (real-time driving data and DTC error code) from the ECU of the vehicle.
- Data received from the OBD. This information will be displayed locally to the user in a smartphone, and also can be sent to a remote web server as HTTP packets in formats as JSON via (Wi-Fi, 2.5G, 3G). The packets received is stored the MySQL database in a server that recorded in the tables, then All results in the backend are displayed on the three web pages.
  - The first webpage for vehicle owner they can go to a web page using an account that register, they allow the user to know the real-time driving status, malfunction error. So, the user can monitor vehicle remotely.
  - The second web page to the maintenance center. It allows knowing the type of error, the status of the vehicle when the error accurate remotely and wherever the vehicle is located.
  - The third web page for an insurance company, we represent a new insurance service, based on the OBD data. The system offers the feature to know the basic



information about the status of the vehicle, and diagnostic error at anytime and anywhere the vehicle located. Applying this feature to system insurance companies can support a wide variety of insurance services, quickly and easily based on real data actually collected by the system.

## Chapter 6

---

### Conclusion and future work

#### 6.1 Conclusion

The thesis proposes an online remote data logging and failure detection in the vehicle critical components using of On-Board Diagnostic (OBD), and 2.5G/3G/4G/WIFI connection techniques. The main parts of the proposed system are on-board diagnostics, application on Smartphone, web server, and web pages.

A vehicle using the Controller Area Network communication protocol. The system requests the stored trouble codes that might have been detected by the diagnostic system, including real-time information such as speed, engine RPM, battery voltage, engine coolant temperature, and other send them together with a Vehicle Identification Number to a web server.

The stored information in a database remote server can be accessed through a web interface. The web page allows the user to find data about a vehicle in the database. Simultaneously, the results can be viewed via Smartphone.

The thesis discussed the planning process, experimental configurations of hardware and software, results of this thesis prove the feasibility of capturing data using a remote system, visualizing the information in real-time. The hardware and software were proven successful by meeting the goals set for research.

## **6.2 Future Work**

In a future development of the proposed system we suggest some point that would be to consider in future work:

- Built hardware device that can receive data from OBD adapter and uploaded to the remote servers autonomously without using smartphones as an intermediate stage.
- Minimize the amount of data transmitted, this can be achieved by compressing the data before transmission using “zip”, “rar” or any similar compression thus even further improves cost-efficiency.
- Installing an OBD II interface that has the ability to monitor in depth all vehicle sensors and accessing PID controllers.

## References

---

- [1] M. Broy, I. H. Kruger, A. Pretschner, C. Salzma , Engineering automotive software, Proceedings of the IEEE 95.2 (2007): 356-373.
- [2] J. Hellberg , M.Pettrsson, Remotely access real-time system in a modern car, Chalmers University of Technology, Sweden, 2013.
- [3]M.Amarasinghe, S.Kottegoda, A.L.Arachchi, ShMuramudalige, H.M.N.D.Pandora, A. Azeez, Cloud-Based Driver Monitoring and Vehicle Diagnostic with OBD2 Telematics,2015 Fifteenth International Conference on (pp. 243-249),In Advances in ICT for Emerging Regions (ICTer),IEEE,2015.
- [4] H. Carpets, Automotive Electronics1, IEEE, Proc. FTCS 25, Vol. 2, pp.87-96,1995 .
- [5] Chong, A. N. D. R. E. W. The growth of automotive electronics in apac, the next frontier. Driving Asia-As Automotive Electronics Transforms a Region (2010).
- [6] T. Denton. Advanced Automotive Fault Diagnosis: Automotive Technology: Vehicle Maintenance and Repair. Routledge, 2016
- [7] Center for Automotive Research, Automotive Technology: Greener Vehicles, Changing Skills, May 2011.
- [8] A. Karimi, J. Olsson & J. Rydell, A Software Architecture Approach to Remote Vehicle Diagnostics, IT UNIVERSITY OF GÖTEBORG, Sweden, 2004.

- [9] P. E. Lanigan, S. Kavulya, P. Narasimhan, Diagnosis in Automotive Systems: A Survey, Carnegie Mellon University, June 2011.
- [10] S. Corrigan, Introduction to the Controller Area Network (CAN), Texas Instruments Incorporated, 2016.
- [11] Z.King, Sh. Yu, Investigating and securing communications in the Controller Area Network (CAN), Computing, International Conference on (pp. 814-818), Networking and Communications (ICNC), IEEE, 2017.
- [12] R. Shaw, B. Jackman, An Introduction to Flex Ray as an Industrial Network, International Symposium on ISIE 2008, Industrial Electronics, IEEE, 2008.
- [13] A. Tahat, A. Said, F. Jaouni, W. Qadamani, Android-Based Universal Vehicle Diagnostic and Tracking System, international symposium, Consumer Electronics (ISCE), 2012 IEEE, 2012.
- [14] Motorsports, Inovate. OT-1 16 Channel OBD-II Interface User Manual. Version 1 (2007): 3-4.
- [15] <http://www.totalcardiagnostics.com/support/Knowledgebase/Article/View/72/15/elm327-review--about-elm-327-obd2-interface>, 15/9/2017.
- [16] J. Lin, Sh.Ch. Chen, Y.T. Shih, and Shi. H. Chen, A Study on Remote On-Line Diagnostic System for Vehicles by Integrating the Technology of OBD, GPS, and 3G, World Academy of Science, Engineering and Technology 56 (2009): 435-441.
- [17] <http://www.totalcardiagnostics.com>, 18/9/2017

- [18] <https://learn.sparkfun.com/tutorials/bluetooth-basics/common-versions>, 28/9/2017
- [19] <https://www.bluetooth.com/what-is-bluetooth-technology>, 28/9/2017
- [20] <http://ccm.net/faq/298-what-is-wifi-and-how-does-it-work>, 29/9/2017
- [21] <http://whatis.techtarget.com/definition/25G>, 29/9/2017
- [22] <https://www.webopedia.com/TERM/3/3G.html>, 29/9/2017
- [23] M.J. Kim, J. W. Jang and Y. S. Yu, A Study on In-Vehicle System using OBD-II with Navigation, IJCSNS International Journal of Computer Science and Network Security, VOL.10 No.9, September 2010.
- [24] D.H. Jung, G.M. Jeong, and H.S . AhnRemote, Vehicle Diagnostic System Using Mobile Handsets, Journal of Korea Multimedia Society 10.10 (2007): 1338-1346.
- [25] H. Jie, L. Changlin, Y. Fuwu, and Z. Zion, The development of a vehicle diagnostic system based on the Android platform, 2015 International Conference on Connected Vehicles and Expo (ICCVE) Institute of Electrical and Electronics Engineers (IEEE). 2015.
- [26] P. Sh. Ganapati, B. A. Dattatraya, Ch. S. Popatrao, R. A. Kadu, Android Based Universal Vehicle Diagnostics and Tracking System, International Journal of Modern Engineering & Management Research, 2014.
- [27] A. Shaout, and A. R. Mir, A Mobile Application for Safer-Intelligent Driving and Vehicle Preventive Maintenance Using Vehicle OBD Data, International Arab Conference on Information Technology (ACIT'2015) proceedings, 2015.

- [28] F. Hengming, Ch. Jia, and X. Bin, The Interaction Mechanism based on JSON for Android Database Application, Information Technology Journal 12 1 (2013): 224-228.
- [29] <http://json.org/>, 8/10/2017.
- [30] [https://www.tutorialspoint.com/sql/sql\\_tutorial/](https://www.tutorialspoint.com/sql/sql_tutorial/), 10/10/2017.
- [31] B.J.Shinde, Dr.S.S.Kore, Dr.S.S.Thipse,Comparative Study Of On Board Diagnostics Systems- EOBD, OBD-I, OBD-II, IOBD-I and IOBD-II, International Research Journal of Engineering and Technology (IRJET),2016.
- [32] <https://github.com/pires/android-obd-reader>,1/12/2017.
- [33]<https://play.google.com/store/apps/details?id=org.prowl.torque>,1/12/2017.
- [34] <https://play.google.com/store/apps/details?id=com.fyp.kampana>,1/12/2017.
- [35]<https://play.google.com/store/apps/details?id=com.pnn.obdcardoctor&hl=ar>,1/12/2017.
- [36]<https://play.google.com/store/apps/details?id=com.palmerperformance.DashCommand&hl=ar>,1/12/2017.

## Appendix A

---



نظام فحص ومراقبة المركبات عن بعد

إعداد: توجان هشام لطفي أبوتمام

إشراف: د. عماد الزير

## الملخص

تتمحور الرسالة حول بناء نظام فحص للمركبات عن بعد يقوم بشكل فوري ومستمر من خلال بوابة ال (OBD-II) والبروتوكولات المعتمدة بالمركبات بإستخلاص المعلومات المتعلقة بعمل أنظمة السيارة الخاصة بالمحرك، وناقل السرعات، وأنظمة السلامة، والأمان، وغيرها من الأنظمة المهمة داخل المركبة حيث يتم نقلها من خلال تقنية (Bluetooth) الى جهاز الهاتف الذكي ومن خلال تطبيق تم تطويره قادر على نقل هذه المعلومات عبر تقنية (Wi-Fi/2.5G/3G) الى جهاز خادم مركزي ليتم تخزينها وتحليلها داخل قاعدة بيانات . ومن ثم عرضها على ثلاث صفحات ويب لتكون متوفرة للجهات ذات العلاقة. إضافة إلى إرسال إشعارات فورية لذوي العلاقة في حال وجود أعطال تتعلف بأداء المركبة. وقد تم فحص هذا النظام على مجموعة من المركبات المختلفة بالتعاون مع الشركة المتحدة للسيارات الالمانية. فعندما تم تحديد عطل داخل المركبة تم نقل البيانات الى الهاتف الذكي ومنها الى الخادم المركزي، وتتضمن معلومات وقت حدوث العطل شاملة كل من معلومات خاصة بالعطل (الرمز والوصف الخاص به) ومعلومات المركبة وقت حدوث هذا العطل مثل (سرعة المركبة، ضغط، درجة الحرارة، وغيرها).

وظهرت المعلومات في ثلاث صفحات ويب الاولى خاصة بمراكز الصيانة حيث تكون عملية البحث عن المركبة المطلوبة عن طريق رقم (VIN) الخاص بالمركبة، وصفحة لشركات التأمين حيث تم اعتماد رقم هوية الشخص للبحث عن المركبة المطلوبة، وصفحة خاصة بصاحب المركبة يقوم عند انشاء الصفحة بتسجيل معلومات عامة خاصة به مثل (رقم الهوية، رقم (VIN)، البريد الالكتروني، ورقم الهاتف) من أجل سهولة الربط الجهات المعنية ومعلومات المركبة الخاصة بالمالك الموجودة على الخادم المركزي. وظهرت النتائج أنه بالإمكان الاعتماد واستخدام هذا النظام في مراقبة وتشخيص المركبات عن بعد، ومدى فعاليته ومساهمته في مساعدة كل مالك المركبة وشركات التأمين ومراكز الصيانة.